

Thanks for choosing the vehicle manufactured by GAC Motor Co., Ltd. (hereinafter referred to as “GAC Motor”). For a better driving pleasure, please read the Operating instructions carefully. Through this manual, you can fully understand the operation methods and precautions of the vehicle. Proper operation of the vehicle can improve driving safety and prolong the service life of the vehicle.

The Warranty and Maintenance Manual supplied with the vehicle clearly describes the warranty services provided by GAC Motor and the regular maintenance of the vehicle. Please read this manual carefully to know your rights and responsibilities.

After reading this manual, please store it with the vehicle for future reference.

In case of any doubts about this manual, please contact the GAC Motor authorized shop for detailed explanation.

If you have any suggestions or recommendations, please contact GAC Motor through the customer service hotline: 400-158-9999.

We are grateful for your support and love for GAC Motor. Have a nice drive!



Safety Instructions



The safety of you and the passengers is crucial, so driving safely is an important responsibility of the driver.

In order to make clear the safety precautions, we provide operation steps and precautions through the various signs on the vehicle and this manual, reminding you to pay attention to the potential dangers that will hurt you or the passengers.

It is impossible to list all the precautions for danger related to operation and maintenance of the vehicle in the manual, so it is up to you to make the correct judgment in time.

Safety instructions are available in many forms, including:

- **Safety signs** - pasted on the vehicle.
- **Safety notes** - the texts marked with the symbols, 、、 and one of the three words "WARNING", "CAUTION" or "NOTE" in front.

 WARNING
 CAUTION
 NOTE

Very important instructions of which the nonobservance can cause casualties.

Important instructions of which the nonobservance can cause damage to the vehicle.

General instructions of which the nonobservance could not cause injuries.

- Some paragraphs of this manual do not apply to all vehicle models. For the description of options, the title of them is followed by the symbol "**".
- Unless otherwise specified, the directions of the vehicle (front, rear, left and right) referred to in this manual are based on the traveling direction of the vehicle.

1. Important Safety Precautions	1
2. Picture index	3
2.1 Exterior	3
2.2 Interior	7
3. Instructions for safe operation	10
3.1 Safe driving.....	10
3.1.1 General description.....	10
3.1.2 Correct sitting posture of the driver and passengers	11
3.2 Seat belt	12
3.2.1 Why must you fasten the seat belt.....	12
3.2.2 Seat belt.....	14
3.3 Supplemental restraint system (SRS)	17
3.3.1 Cases where the airbags may deploy.....	22
3.3.2 Cases where the airbags might not deploy	23
3.4 Safe ride of children.....	24
3.4.1 General description.....	24
3.4.2 Child safety seat	25
3.4.3 Information about child safety seat.....	27
3.4.4 Correct installation of child safety seat ...	29
3.5 Exhaust gas hazard	33
3.6 Safety label	34

4. Operation of systems and equipment	35
4.1 Cab	35
4.1.1 Steering wheel	35
4.1.2 Instrument cluster	37
4.1.3 Indicator lamp	44
4.2 Vehicle locking and unlocking.....	48
4.2.1 Remote control key	48
4.2.2 Emergency mechanical key	52
4.2.3 Door lock system	53
4.2.4 Flush door handle	58
4.2.5 Door	60
4.2.6 Liftgate	60
4.2.7 Engine hood.....	65
4.2.8 Power window.....	67
4.2.9 Power sunroof*	69
4.2.10 Basic operation of body anti-theft system	74
4.3 Lamps and vision	75
4.3.1 Exterior lamps	75
4.3.2 Interior lamp	80
4.3.3 Wiper combination switch	82
4.3.4 Windshield	85
4.3.5 Rearview mirror	85
4.3.6 Sun visor	88

Table of contents

4.4	Seats and storage facilities.....	89	4.6.8	Emergency rescue*	127
4.4.1	Head restraint	89	5. Driving Guide	128	
4.4.2	Front seats.....	90	5.1	Starting and driving.....	128
4.4.3	2nd-row seat	92	5.1.1	START/STOP button.....	128
4.4.4	Storage facilities	92	5.1.2	Engine start.....	129
4.4.5	Low battery reminder	95	5.1.3	Engine shutdown	130
4.4.6	Static current management function	96	5.1.4	Instruction for gear.....	131
4.4.7	Power outlet/USB port	96	5.1.5	Exhaust sound*.....	134
4.4.8	Mobile phone wireless charging system*	98	5.2	Brake system	135
4.4.9	Trunk.....	101	5.2.1	Service brake.....	135
4.4.10	Accessories and modification	102	5.2.2	Electric park brake (EPB)	138
4.5	A/C system	105	5.3	Electronic service brake system	142
4.5.1	General description.....	105	5.3.1	Electronic stability program (ESP)	142
4.5.2	A/C system	106	5.3.2	Anti-lock braking system (ABS)	144
4.5.3	A/C vent	111	5.3.3	Hill hold control (HHC).....	146
4.6	AV system	113	5.3.4	Hill descent control (HDC)*	146
4.6.1	Control buttons on the right of steering wheel*.....	113	5.4	Driver assistance systems	147
4.6.2	Custom buttons on steering wheel*	114	5.4.1	Cruise control system*	147
4.6.3	Basic operation	115	5.4.2	Adaptive cruise control (ACC)*	149
4.6.4	Radio	118	5.4.3	Integrated cruise assist (ICA) system*..	159
4.6.5	Music	119	5.4.4	Forward collision mitigation (FCM) system*	165
4.6.6	Bluetooth function.....	120	5.4.5	Traffic sign recognition (TSR)*	170
4.6.7	System settings	122			

5.4.6	Intelligent speed limit adaptive cruise control (ISL-ACC)*.....	172	6.4.1	Fuel.....	219
5.4.7	Lane departure warning (LDW) system*.....	174	6.4.2	Engine oil.....	221
5.4.8	Intelligent high beam control (IHC)*.....	179	6.4.3	Coolant.....	224
5.4.9	Radar and IFC sensor*.....	181	6.4.4	Windshield washer fluid and wiper blades.....	227
5.4.10	Tire pressure monitoring system (TPMS).....	184	6.4.5	Brake fluid.....	229
5.5	Parking assist system (PAS).....	186	6.4.6	Battery.....	231
5.5.1	Reversing parking aid (RPA)*.....	186	6.5	A/C filter.....	233
5.5.2	Around view monitor (AVM)*.....	191	6.6	Replacing bulb.....	233
5.5.3	Fusion automatic parking assist (FAPA)*.....	198	6.7	Wheel.....	236
5.6	Electric power steering (EPS).....	206	6.8	Tire chain.....	241
5.7	Driving skills.....	207	7. Technical Data	243	
5.7.1	Pre-driving safety inspection.....	207	7.1	VIN.....	243
5.7.2	Driving during running-in period.....	207	7.2	Dimensions & parameters of vehicle.....	245
5.7.3	Driving essentials.....	209	7.3	Vehicle mass & parameters of engine and fluids.....	247
5.7.4	Efficient use of vehicle.....	210	7.4	Specifications of transmission, chassis and vehicle lamps.....	250
5.7.5	Fire prevention.....	211	7.5	Fuse specification.....	253
6. Operation and maintenance	213		8. Accident handling	259	
6.1	Maintenance instructions.....	213	8.1	Driver's tools and spare tire.....	259
6.2	Interior maintenance.....	213	8.2	Use of warning triangle.....	260
6.3	Exterior maintenance.....	215	8.3	Use of reflective vest.....	261
6.4	Inspecting and adding fluids.....	219			

Table of contents

8.5	Replacing flat tires	261
8.5	Fuse.....	265
8.6	Emergency start	267
8.7	Vehicle towing.....	269
8.8	Getting out of a trap	271

1. Important Safety Precautions

◆ Be sure to fasten the seat belt correctly

The seat belt is the best protection device in the event of a collision. Airbags are only designed as auxiliaries, rather than replacements, of the seat belts, so even if the vehicle is equipped with airbags, make sure that you and the passengers always fasten the seat belts correctly.

◆ Do not leave children in an unattended vehicle

Do not leave children in an unattended vehicle, as injury or even death may occur if they trigger a control device accidentally, or when the vehicle is moved accidentally and collided with other objects due to their mis-operation, and besides, the temperature inside the vehicle may reach an extreme condition, depending on the ambient temperature.

◆ Protect all children

Children aged 12 or under should be properly restrained in the 2nd-row seats rather than the front seats. Child safety seats shall be used for infants and toddlers; Older children should be restrained in child safety seats with three-point seat belts before they know how to use the seat belt properly (without any child seat booster).

◆ Risk of airbag

Airbags can save lives, but they can also cause serious or fatal injuries to occupants who are too close to the airbags or improperly restrained.

Airbags pose the greatest risk to infants, toddlers and short adults, so please follow all instructions and warnings in this manual.

◆ Do not drink and drive

Drinking alcohol, even a little, will reduce your response capability, and your reaction time after drinking will become longer, so drinking and driving is strictly prohibited.

◆ During driving, please abide by the road traffic safety laws and yield to pedestrians.

◆ Be sure to pay attention to driving safety

Traffic accident will occur if you are busy answering the phone or handling other things so that you can not pay attention to road conditions, other traffics and pedestrians during driving. Please avoid distraction during driving.

◆ Control vehicle speed

Excessive speed is one of the main causes of traffic accidents. The faster the speed is, the greater the risk will be. Therefore, please choose the appropriate speed for safe driving according to the actual road conditions.

◆ Regular maintenance

Tire burst or mechanical failure is very dangerous. In order to reduce the possibility of such problems, please check the tire pressure and status frequently, and carry out regular maintenance as specified in the Warranty Manual.

1. Important Safety Precautions

Event data recorder (EDR)

This vehicle is equipped with an event data recorder (EDR). The EDR is mainly designed to record data in the event of certain collisions (such as airbag deployment or collision with a barrier), so as to help understand the operation of the vehicle system. EDR is specially used to record data related to vehicle dynamic control and safety systems in a short period of time. However, depending on the severity and type of collision, data may not be recorded.

The data specially recorded by the EDR of this vehicle include:

- status of driver depressing the brake pedal (if applicable).
- Vehicle driving speed.
- Vehicle longitudinal acceleration.
- VIN.

These data help better understanding the situation in the event of a collision and personal injury, and are used to assist accident analysis.

i NOTE

The EDR will record data only when a certain degree of collision occurs to the vehicle; EDR will not record data during normal driving.

EDR data disclosure

Except for the following circumstances, GAC Motor (Hangzhou) will not disclose the data recorded in the EDR to third parties:

- Reaching an agreement with the owner (or the lessee of the rental vehicle).
- At the official request of the police, courts or government agencies.

If necessary, the data will be used in:

- Research on vehicle safety performance.

How to obtain EDR data reading tool

Special technical equipment is required to read EDR data. For more information, please contact GAC Motor authorized shop.

2.1 Exterior

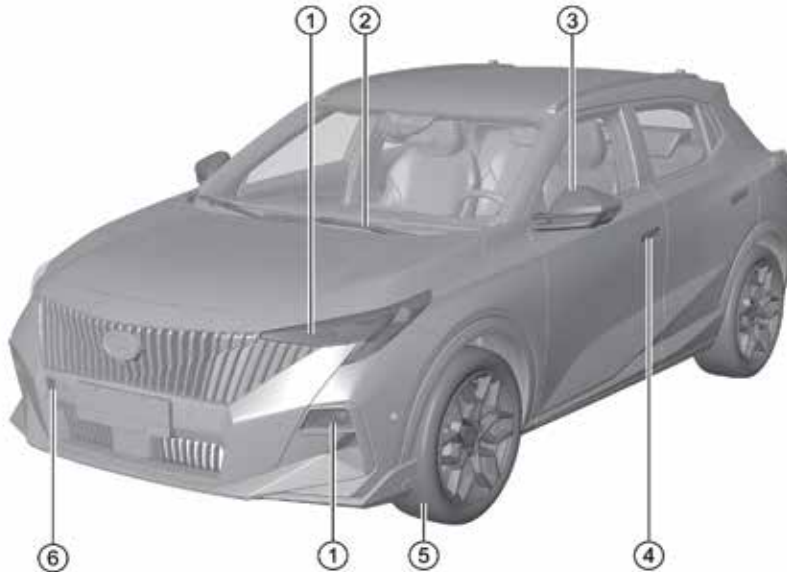

- ① Front combination lamp
 - Turning on light => [See page 75](#)
 - Replacing bulb => [See page 233](#)
 - Specification of front combination lamp bulb => [See page 252](#)
- ② Front wiper
 - Replacing front windshield wiper blade => [See page 228](#)
- ③ Exterior review mirror
 - Side turn signal lamp => [See page 75](#)
 - Specification of side turn signal lamp => [See page 252](#)
- ④ Flush door handle => [See page 58](#)
 - Door lock hole => [See page 54](#)
- ⑤ Wheels => [See page 236](#)
- ⑥ Front towing => [See page 270](#)

2. Picture index

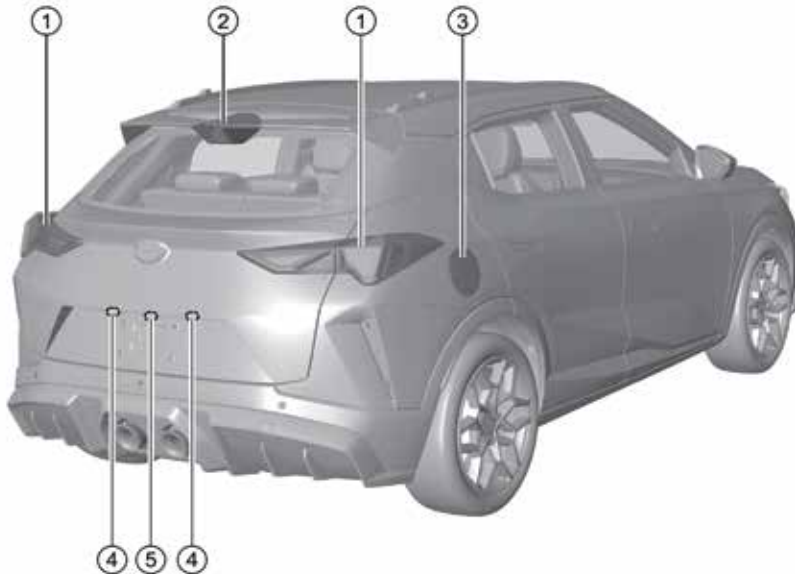

Type 1:

- ① Rear combination lamp
 - Specifications of rear combination lamp bulb => [See page 252](#)
 - Specifications of rear fog lamp (left side) => [See page 252](#)
 - Specifications of reverse lamp (right side) => [See page 252](#)
- ② High-mounted stop lamp
 - Specification of high-mounted stop lamp => [See page 252](#)
- ③ Fuel tank cap => [See page 219](#)
- ④ License plate lamp
 - Specification of license plate lamp => [See page 252](#)
- ⑤ Liftgate opening button => [See page 61](#)

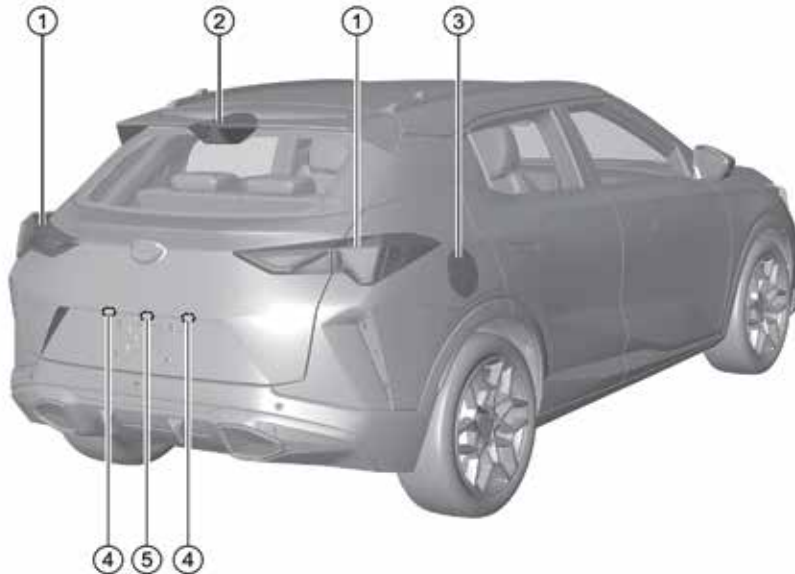

Type 2:

- ① Rear combination lamp
 - Specifications of rear combination lamp bulb => [See page 252](#)
 - Specifications of rear fog lamp (left side) => [See page 252](#)
 - Specifications of reverse lamp (right side) => [See page 252](#)
- ② High-mounted stop lamp
 - Specifications of high-mounted stop lamp => [See page 252](#)
- ③ Fuel tank cap => [See page 219](#)
- ④ License plate lamp
 - Specifications of license plate lamp => [See page 252](#)
- ⑤ Liftgate opening button => [See page 61](#)

2. Picture index

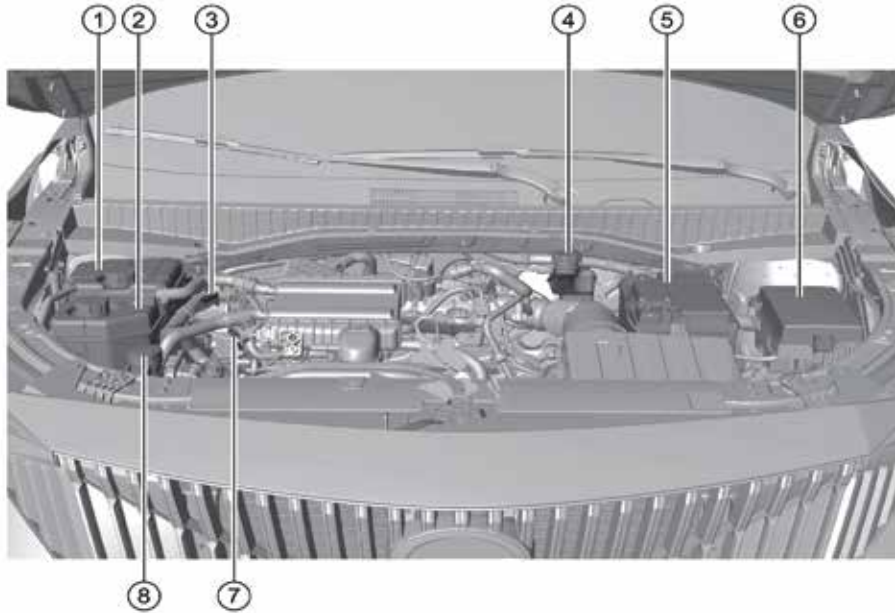

- ① Engine coolant reservoir => See page 225
- ② Intercooler coolant expansion tank => See page 225
- ③ Oil filler cap => See page 223
- ④ Brake fluid reservoir => See page 230
- ⑤ Battery => See page 231
- ⑥ Engine compartment electrical box => See page 265
- ⑦ Oil scale => See page 222
- ⑧ Windshield washer fluid reservoir => See page 227

2.2 Interior

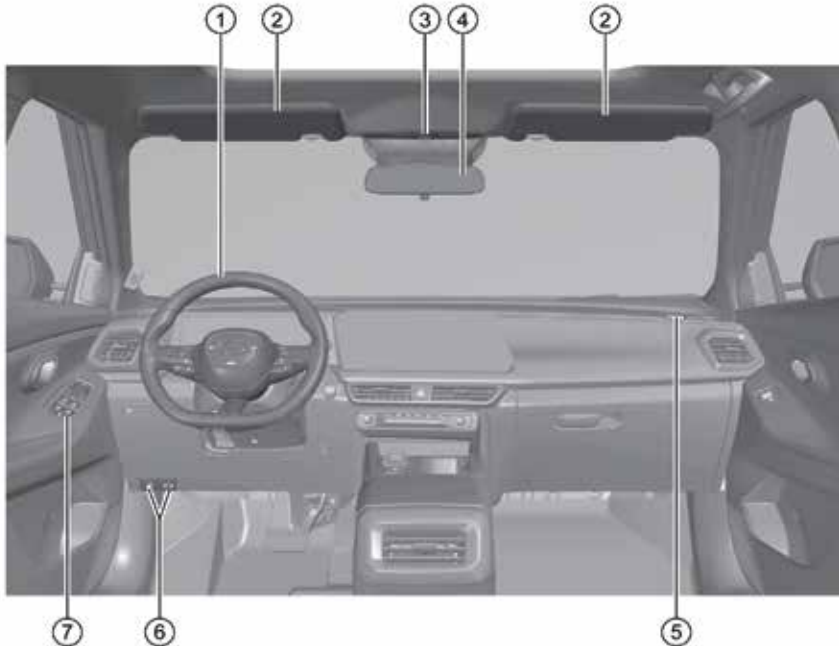

- ① Steering wheel => See page 35
 - Steering wheel buttons => See page 36
 - Driver's frontal airbag => See page 18
- ② Sun visor => See page 88
- ③ Front dome lamp => See page 80
 - Power sunroof control button => See page 70
 - Power sunshade button* => See page 69
 - SOS button * => See page 127
- ④ Interior rearview mirror => See page 85
- ⑤ Front passenger's frontal airbag => See page 19
- ⑥ Engine hood release handle => See page 65
 - Fuel filler flap release handle => See page 219
- ⑦ Driver's power window control button => See page 67
 - Exterior rearview mirror folding button => See page 87
 - Exterior rearview mirror adjusting button => See page 86
 - Central locking button => See page 53

2. Picture index

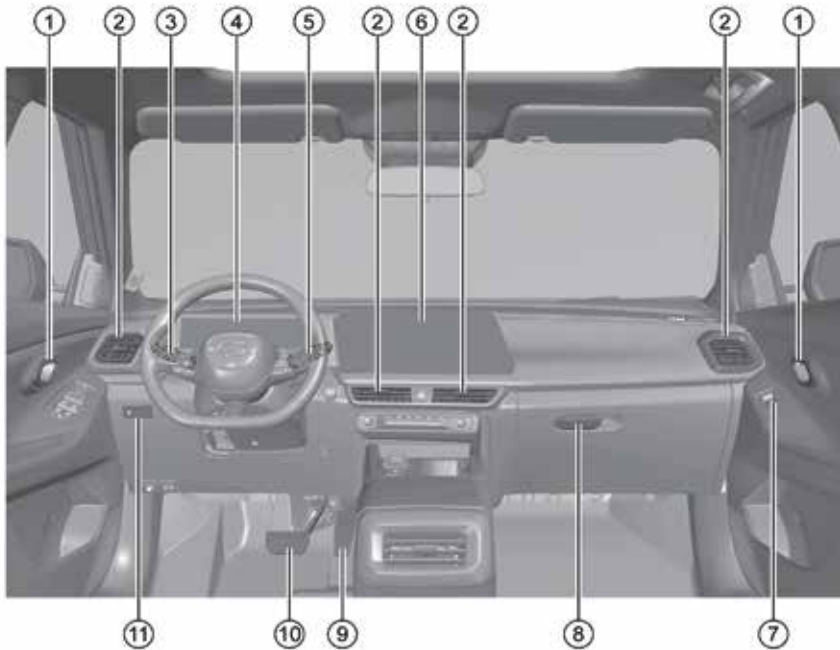

- ① Inside handle => See page 53
- ② A/C vent => See page 111
- ③ Lamplight combination switch => See page 75
- ④ Instrument cluster => See page 37
- Indicator lamp => See page 44
- ⑤ Wiper combination switch => See page 82
- ⑥ AV system => See page 115
- ⑦ Passenger's power window control button => See page 68
- ⑧ Glove box release handle => See page 95
- ⑨ Accelerator pedal
- ⑩ Brake pedal
- ⑪ Manual headlamp leveling knob => See page 78

2. Picture index

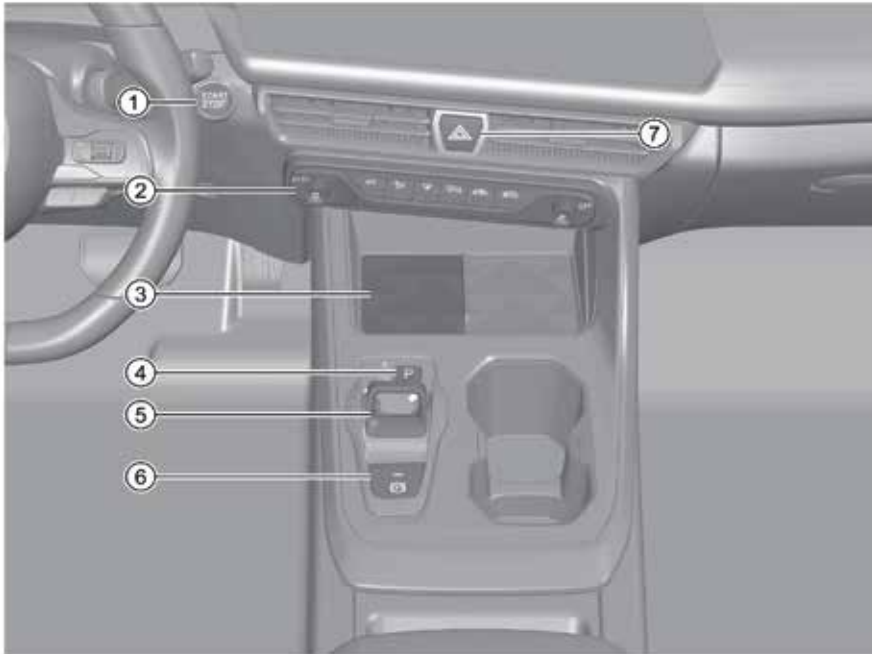

- ① START/STOP button => See page 128
- ② A/C control button => See page 106
- ③ Mobile phone wireless charging area* => See page 98
- ④ "P" button => See page 131
- ⑤ Transmission shift lever => See page 131
- ⑥ EPB button => See page 138
- ⑦ Hazard warning lamp switch button => See page 79

3. Instructions for safe operation

3.1 Safe driving

3.1.1 General description

This section introduces important information, operating essentials, recommendations and safety precautions for safe driving. For the safety of you and the passengers, please read carefully and follow the relevant regulations.

NOTE

Please always keep the *Operating instructions* in the vehicle. If you lend or resell the vehicle to someone else, be sure to hand the complete set of accompanying documents over to the new owner.

The following inspections must be carried out before driving:

- Check that all lamps are working properly.
- Check that the fuel level is normal.
- Check that the coolant level is normal.
- Check that the brake fluid level is normal.
- Check that the oil level is normal.
- Check that the windshield washer fluid level is normal.
- Check that the tire pressure is normal.
- Check that the engine hood is closed and locked properly.
- Check that all windows are clear and have a good view.
- Check that no objects obstruct the movement of the driver's foot pedals.
- Adjust the seat, head restraint and rearview mirror according to your body height and shape.
- Use appropriate child safety seats to protect children and help them fasten the seat belts correctly.
- Fasten the seat belt correctly and remind all passengers in the vehicle to fasten the seat belts.



WARNING

When installing the driver's floor mat, please observe the following precautions:

- Do not overlap two or more floor mats.
- Do not make the bottom surface of the floor mat upward or back-to-front.
- Do not use floor mats that are incompatible with this model.



CAUTION

- Do not distract yourself from external factors during driving.
- Do not drive the vehicle when your response capability reduces, such as due to medicines, alcohol, or drugs.
- Strictly abide by traffic regulations.

3.1.2 Correct sitting posture of the driver and passengers

Correct sitting posture of the driver

The driver's sitting posture directly affects his/her fatigue level and driving safety. Before driving, the driver should:

- Sit up straight and adjust the seat back to a suitable position so that your back fits completely the seat back.
- Adjust the seat position so that all pedals can be operated effectively with slightly bent legs.
- Correctly adjust the headrest. => See page 89
- Fasten the seat belt correctly. => See page 15
- Adjustment of the steering wheel position => See page 35

WARNING

Do not adjust the seat, headrest or steering wheel during driving; otherwise the vehicle may be out of control, leading to an accident.

Correct sitting posture of the passengers

To guarantee the safety of the passengers and reduce the risk of casualties, the passengers should:

- Sit up straight and adjust the head restraint of the seat correctly. => See page 89
- Adjust the distance between the seat and the instrument panel as demanded (for front passenger).
- Adjust the seat back until the back fits completely the seat back (for front passenger).
- Fasten the seat belt correctly. => See page 15
- Place both feet on the floor.
- Use appropriate child safety seat in accordance with applicable regulations for children. => See page 25

WARNING

- It is forbidden to install a child safety seat in the front passenger's seat.
- If the front passenger is too close to the instrument panel, the SRS will not provide effective protection.
- When the vehicle is running, be sure to maintain a correct sitting posture and fasten the seat belt correctly, so as to avoid unexpected injuries in case of emergency braking or accidents.

3. Instructions for safe operation

3.2 Seat belt

3.2.1 Why must you fasten the seat belt

Protection of the driver and passengers by seat belts



In the event of a vehicle collision, the seat belt, if fastened correctly, can restrain the driver and passengers in a proper position and slow down the inertia of their forward movement, thus preventing them from being thrown forward, and at the same time allow airbags to give them the best protection, thus reducing their impact injury as much as possible.

In the event of a collision, the seat belt will assist other safety systems in simultaneously absorbing the energy generated by the collision, further reducing the injuries suffered by the driver and passengers.

WARNING

Airbags cannot replace seat belts. Regardless of whether the car is equipped with airbags, the seat belts should be worn correctly.

Consequences of not fastening the seat belt

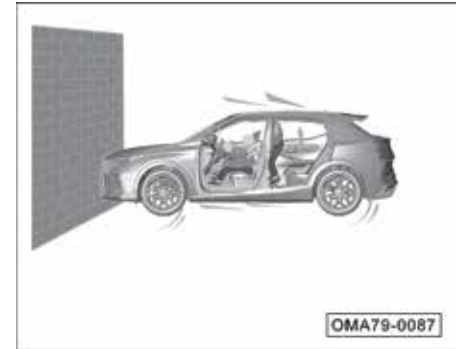

In the event of a collision, the driver or passenger who does not fasten the seat belt will be thrown forward due to inertia and thereby injured.

3. Instructions for safe operation



Even if the vehicle speed is very low, the force acting on the human body in the event of a collision is so great that the occupant cannot control his or her body with hands at all. In that case, the occupant who does not fasten the seat belt will be thrown forward, and injured if colliding with any interior objects.



Rear passengers must also fasten the seat belts correctly, otherwise they will be thrown forward when an accident occurs. The occupant who does not fasten the seat belt will not only hurt himself or herself, but also endanger other occupants in the car.

3. Instructions for safe operation

3.2.2 Seat belt

Seat belt indicator lamp

: Driver's seat belt indicator lamp

: Front passenger's seat belt indicator lamp

The following alarms will be triggered when the vehicle power switch is set to "ON" position:

- If the driver or front passenger does not fasten the seat belt at a speed lower than 20km/h, the corresponding indicator lamp on the instrument cluster will flash and stay on.
- If the driver or front passenger does not fasten the seat belt at a speed higher than or equal to 20km/h, the corresponding indicator lamp on the instrument cluster will flash for a few seconds and stay on, accompanied by an alarm message and a continuous audible alarm.

CAUTION

- Before driving, please check whether there are any heavy objects on the front passenger's seat to avoid the system mistakenly determining that the seat is occupied and issuing a false alarm.
- If the alarm information remains on after the seat belt is fastened correctly, it means that the SRS is failed. In that case, please contact the GAC Motor authorized shop for inspection in time.

WARNING

Never insert the substitute of seat belt tongue into the buckle to eliminate the seat belt alarm.

: Rear seat belt indicator lamp*

If rear seat belt indicator lamp is on in white, it indicates that the seat belt is fastened, and if the indicator lamp is on in red, it indicates that the seat belt is not fastened or the seat belt system is faulty. If the indicator lamp stays red after the seat belt is fastened correctly, it means that the SRS is failed. In that case, please go to the GAC Motor authorized shop for inspection in time.

The 2nd-row seat belt indicator lamp comes on for a period of time and then goes out. It will light up again under the following conditions:

- The 2nd-row passenger does not fasten the seat belt when the engine starts.
- The 2nd-row passenger does not fasten the seat belt when the rear door is opened/closed.
- The 2nd-row passenger fastens or unfastens the seat belt.

3. Instructions for safe operation

Seat belt pretensioner and load limiter *



The seat belt pretensioner and load limiter can reduce the pressure of the seat belt on the chest of the driver or passenger and improve the protection performance.

- Before the collision, the seat belt pretensioner and load limiter can restrain the driver or passenger and enable him or her to maintain a correct sitting posture to prevent the body from leaning forward.
- In the event of a severe collision where the triggering condition is reached, the seat belt pretensioner and load limiter will be triggered, driving the seat belt webbing to be quickly retracted and tensioned.

- When a vehicle collision occurs, the human body will move forward, and the seat belt load limiter will be activated at this time, so that the restraint force of the seat belt on the human body will be within a certain range, preventing the occupant from being further injured due to excessive force. And at the same time, the seat belt pretensioner and load limiter will work with the airbag to achieve a better safety protection performance.

i NOTE

- When the seat belt pretensioner and load limiter is activated, a little harmless smoke together with a sound will be produced, which is normal.
- Seat belt pretensioner and load limiter cannot be used any more if deployed, and in this case,  the SRS indicator lamp stays on, please contact the GAC Motor authorized shop for replacement.

Fastening the front seat belt



- Keep a correct sitting posture. => See [page 11](#)
- Pull out the seat belt slowly at a uniform speed, insert the lock tongue into the corresponding buckle until a click sound is heard.
- Pull the seat belt tongue and confirm that the tongue is properly locked.

i NOTE

The rear seat belts are fastened in the same way, and the driver is responsible for reminding passengers to fasten the seat belts correctly.

3. Instructions for safe operation

Unfastening the seat belt



- Press the red button of the buckle. Then the lock tongue will pop out automatically.
- Grasp the seat belt to allow it to retract slowly.

Pregnant women must fasten the seat belts correctly



How does a pregnant woman correctly fasten the seat belt?

- Adjust the seat and head restraint to the proper position.
- Grasp the lock tongue, slowly pull the seat belt over the shoulder, and ensure that the lap belt is as low as possible and not pressed against the abdomen.
- Insert the tongue into the buckle till a buckling sound is heard.
- Pull the shoulder belt upward parallel to the upper body, tension the lap belt, and make sure that the lock tongue is properly locked.

WARNING

To reduce the risk of injury during emergency braking or accidents, please observe the following precautions:

- Before driving, make sure that all occupants have properly fastened the seat belts.
- Each seat belt is for one person only. Do not share a seat belt with other persons (including children).
- Not recline the front seat back excessively for comfort.
- Not put the shoulder belt under or behind your arm.
- Be sure to insert the lock tongue into the buckle of corresponding side instead of the buckle of other side.
- Never unfasten the seat belt before the vehicle comes to a complete stop.

3.3 Supplemental restraint system (SRS)

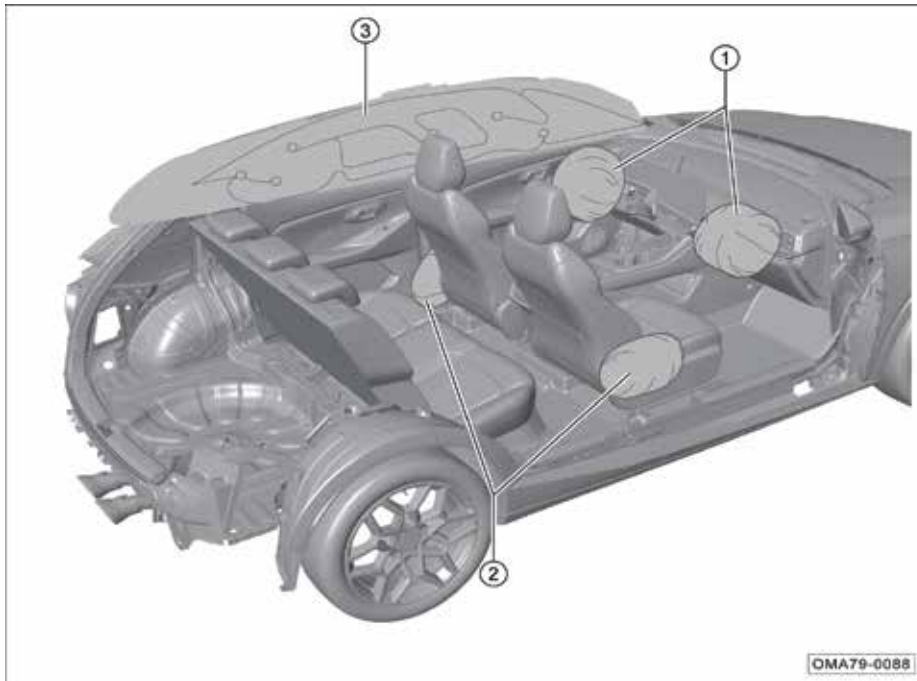

Depending on vehicle configurations, the deployment positions of the SRS are as shown below:

- ① Front seat frontal airbag
- ② Front seat side airbag*
- ③ Side curtain airbag (LH SHOWN, RH OPPOSITE)*

i NOTE

The airbag will produce a little harmless smoke when deployed, which is normal.

3. Instructions for safe operation

Supplemental restraint system (SRS) indicator lamp

With the START/STOP button set to “ON” position,  the indicator lamp will be on for a few seconds and go out after the system completes self-test.

A system fault is indicated when the indicator lamp  is in the following conditions:

1. The indicator lamp does not come on after the START/STOP button is set to “ON” position.
2. With the START/STOP button set to “ON” position, the indicator lamp does not go out after the system completes self-test.
3. After the START/STOP button is set to “ON” position, the indicator lamp goes out, but then comes on again.
4. The indicator lamp comes on or flashes while the vehicle is running.

WARNING

- **Attempt to repair, adjust or modify the airbag.**
- **The airbag can be deployed once only, and thus, if it is deployed in the event of an accident, please contact the GAC Motor authorized shop for replacement.**
- **When the SRS is faulty, please contact the GAC Motor authorized shop for inspection. Otherwise, the system cannot trigger or abnormally triggers the airbag in the event of a vehicle collision.**

Front seat frontal airbag



The driver's frontal airbag is installed inside the steering wheel (as indicated by the dotted dash) marked with "AIRBAG".

3. Instructions for safe operation



The front passenger's frontal airbag is installed inside the instrument panel (as indicated by the dotted dash) marked with "AIRBAG".

In the event of a frontal collision which is severe enough to meet the triggering condition of frontal airbag, the frontal airbags will be triggered by the system and deploy rapidly to assist the seat belt in protecting the driver and front passenger.

In certain collision accidents, the system may simultaneously trigger other airbags.

WARNING

Do not attach or place any decorative objects on the surface of instrument panel, because when the vehicle is running or the airbag deploys, these objects will fall, be knocked over and roll around in the vehicle, affecting the driver and hurting the passengers in the vehicle.

The front seat frontal airbags might not be triggered in the following cases:

- The START/STOP button set to "ACC" or "OFF" position.
- Minor frontal collision.
- Side collision.
- Rear-end collision.
- Rollover.
- Other special circumstances.

NOTE

The word "minor" refers to the extent with respect to the car SRS controller and has nothing to do with the damage of the car.

3. Instructions for safe operation

Front seat side airbag*



The front seat side airbags are installed in the outboard sides of the driver's seat back and the front passenger's seat back respectively (as indicated by the dotted dash) marked with "AIRBAG".

In the event of a side collision which is severe enough to meet the triggering condition of frontal airbag, the side airbags will be triggered by the system and deploy rapidly to assist the seat belt in protecting the driver and front passenger.

In certain collision accidents, the system may simultaneously trigger other airbags.

The front seat frontal airbags system might not be triggered in the following cases:

- The START/STOP button set to "ACC" or "OFF" position.
- 100% frontal collision.
- Minor side collision.
- Rear-end collision.
- Other special circumstances.

i NOTE

The word "minor" refers to the extent with respect to the car SRS controller and has nothing to do with the damage of the car.

⚠ WARNING

- **Do not lean your body against the door equipped with a side airbag while driving.**
- **Do not cover the side airbags with seat covers or other objects; otherwise, the side airbags will not protect the occupants when an accident occurs.**

Side curtain airbag*

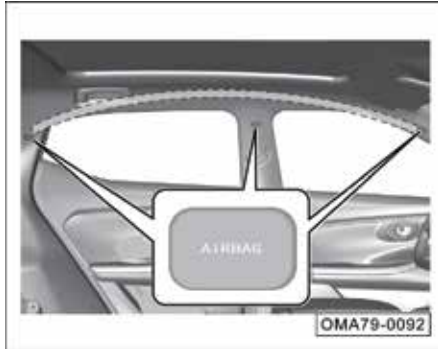

The side curtain airbags are installed in the left and right sides of the roof respectively (as indicated by the dotted dash) marked with "AIRBAG".

In the event of a side collision which is severe enough to meet the triggering condition of side curtain airbag, the curtain airbag on the side where the collision occurs will be triggered by the system and deploy rapidly to assist the seat belt in protecting the driver and front passenger.

In certain collision accidents, the system may simultaneously trigger other airbags.

The side curtain airbags might not be triggered in the following cases:

- The START/STOP button set to "ACC" or "OFF" position.
- 100% frontal collision.
- Minor side collision.
- Rear-end collision.
- Other special circumstances.

i NOTE

The word "minor" refers to the extent with respect to the car SRS controller and has nothing to do with the damage of the car.

3. Instructions for safe operation

3.3.1 Cases where the airbags may deploy

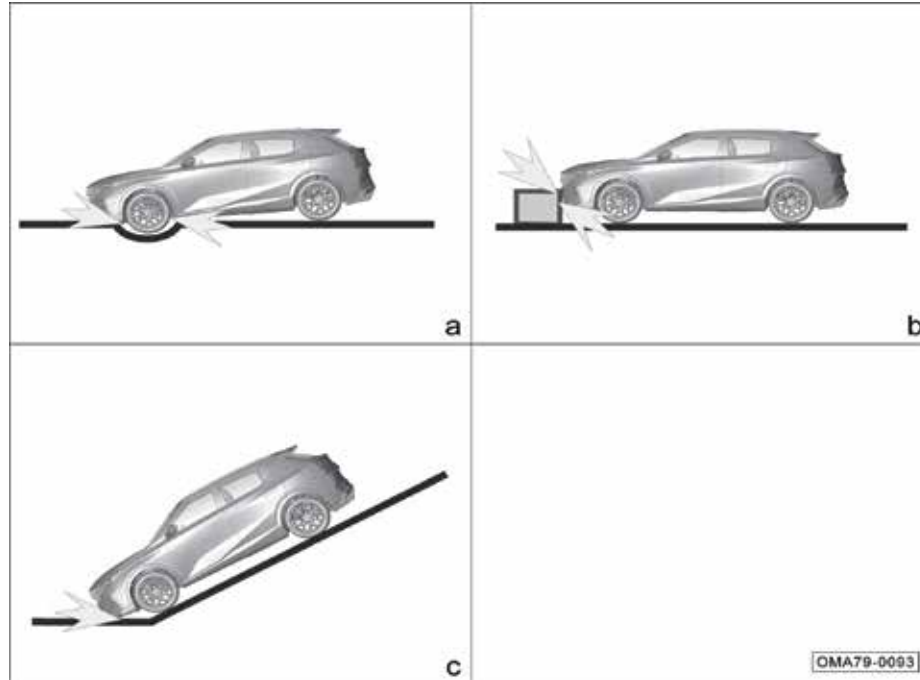

- a: Nose-down to the ground when the vehicle crosses a deep groove.
- b: Collision with roadside protrusions, curbs, etc.
- c: Nose-down to the ground when the vehicle runs down a steep slope.

3. Instructions for safe operation

3.3.2 Cases where the airbags might not deploy

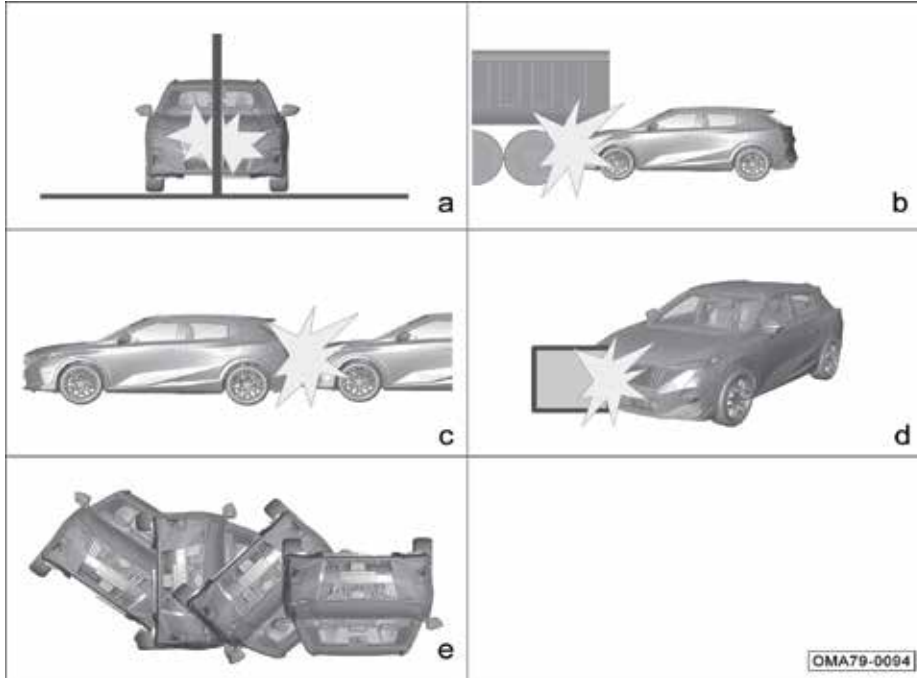

- a: Collision with concrete pillars, trees or other elongated objects.
- b: Rear-end collision with the lower rear end of large truck.
- c: Rear-end collision by other vehicles.
- d: Collision with a wall or another vehicle, other than frontal collision.
- e: Rollover.

3. Instructions for safe operation

3.4 Safe ride of children

3.4.1 General description

The child must sit in a 2nd-row side seat, and a suitable child safety seat should be selected for protection according to the body size of the child.



Warning labels are pasted on the front and back of the right sun visor to remind the front passenger of the danger of frontal airbag. Be sure to read and follow the instructions on the labels.

⚠ WARNING

- Do not install any rear-facing child restraint system on seats with frontal airbags!
- Even if the child has been put in a child safety seat, do not let the head or any part of the body rest on the door area (the deployment area of the front seat side airbag* or side curtain airbag*); otherwise the impact force of the deployed front seat side airbag* or side curtain airbag* can cause serious injury or even death of the child.
- Do not let children stand or kneel on the seat.
- Do not allow children to operate devices that may cause pinch to themselves (such as power window, electric sunroof*, etc.).

⚠ WARNING

- Never leave children alone in the vehicle!
- Never hold infants or toddlers on your knees!
- Seat belts are not suitable for infants and toddlers as they can cause injuries in the event of an accident.
- Ensure that in the event of a collision or emergency braking, children are less likely to be injured by hitting any hard objects in the vehicle.
- Lock the child safety lock of the door on the side where the child sits. =>
See page 55

3. Instructions for safe operation

3.4.2 Child safety seat



a. Group 0/0+ child safety seats



b. Group I child safety seats



c. Group II child safety seats



d. Group III child safety seats

Classification of child safety seats (for reference only):

- a. Group 0/0+ Child safety seat
 - Suitable for infants weighing less than 13kg.
- b. Group I child safety seats:
 - Suitable for toddlers weighing between 9kg and 18kg. For children weighing up to 18 kg (3 years old), rear-facing child safety seats must be installed.
- c. Group II child safety seats:
 - Suitable for children weighing between 15kg and 25kg.
- d. Group III child safety seats:
 - Suitable for children weighing between 22kg and 36kg.

3. Instructions for safe operation

WellDon Angela 2nd Generation is recommended for Group I child safety seat, and the product model is WD002–ZJC.

Precautions for installation:

- Adjustment of seat body: Rear-facing seat is recommended. Adjust the seat body to make it most upright (nearly vertical).
- Adjustment of headrest: It is recommended that the headrest of the child safety seat be flush with the shoulder of the child.
- It is recommended to fix the top tether hook to the anchorage at the rear of seat back.
- It is recommended to take the path of top tether around both sides of the child safety seat headrest.
- The clip gasket and shoulder belt jacket are recommended.

i NOTE

During the actual installation of the child safety seat, be sure to refer to the instruction of the child safety seat for correct installation.

3. Instructions for safe operation

3.4.3 Information about child safety seat

Information about the applicability of different seating positions for child restraint systems:

Weight group	Mounting position		
	Front passenger's seat	Outboard 2nd-row seats	2nd-row center seat
Group 0: <10 kg	X	U	X
Group 0 +: <13 kg	X	U/UF	X
Group I: 9~18kg	X	U/UF/L	X
Group II: 15~25kg	X	UF	X
Group III: 22~36kg	X	UF	X

Note: The uppercase letters in the table are defined as follows:

U= The "general" child restraint systems approved for this weight group are suitable.

UF= The forward-facing "general" child restraint systems approved for this weight group are suitable.

L= The listed special child restraint systems are suitable, which may be for special vehicles, or of restricted or semi-general categories.

X= The child restraint systems approved for this weight group are not suitable.

For some child safety seats, a size class is specified. Be sure to check the size class according to the manufacturer's instructions, packaging, and child safety seat label. For guidance on proper installation, please refer to the instruction of the child safety seat.

3. Instructions for safe operation

ISOFIX mounting positions for ISOFIX child safety seats

Weight group	Size class	Fixture module	Mounting position		
			Front passenger's seat	Outboard 2nd-row seats	2nd-row center seat
Carry-cot	F	ISO/L1	X	X	X
Group 0: <10 kg	G	ISO/L2	X	X	X
	E	ISO/R1	X	IUF/IL	X
Group 0 +: <13 kg	E	ISO/R1	X	IUF/IL	X
	D	ISO/R2	X	IUF/IL	X
	C	ISO/R3	X	IUF/IL	X
Group I: 9~18kg	D	ISO/R2	X	IUF/IL	X
	C	ISO/R3	X	IUF/IL	X
	B	ISO/F2	X	IUF/IL	X
	B1	ISO/F2X	X	IUF/IL	X
	A	ISO/F3	X	IUF/IL	X
Group II: 15~25kg	-	-	X	IUF	X
Group III: 22~36kg	-	-	X	IUF	X

Note: **The uppercase letters in the table are defined as follows:**

IUF - The “forward-facing” general ISOFIX child safety seats for this weight group that are fixed with top tether are suitable.

IL - The listed special ISOFIX child restraint systems are suitable, which may be for special vehicles, or of restricted or semi-general categories.

X - The child safety seats for this weight group are not suitable.

For some child safety seats, a size class is specified. Be sure to check the size class according to the manufacturer's instructions, packaging, and child safety seat label. For guidance on proper installation, please refer to the instruction of the child safety seat.

3. Instructions for safe operation

3.4.4 Correct installation of child safety seat

The child safety seat is installed by three-point seat belt, ISOFIX system, or LATCH system.

To ensure a better protection effect and prevent the headrest from affecting the performance of the child safety seat during use, it is recommended to remove the headrest of the seat on which the child safety seat is installed.

i NOTE

During the actual installation of the child safety seat, be sure to refer to the instruction of the child safety seat for correct installation.

Installation of child safety seat by three-point seat belt



1. Place the child safety seat on the second seat.
2. Pass the seat belt through the child safety seat and fully insert the tongue into the buckle until a click sound is heard.

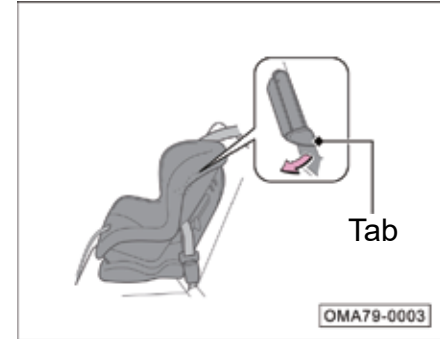

3. Push the tab down and pass the shoulder belt through the slit on the side of the child safety seat.

3. Instructions for safe operation

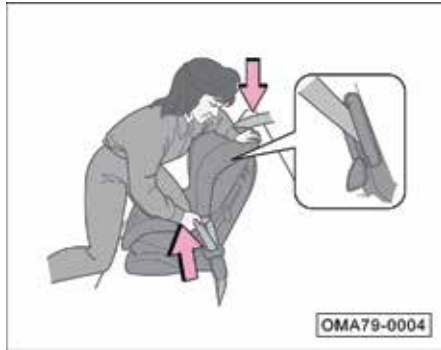

4. Grasp the shoulder belt near the buckle and pull it up to tension the lap belt. At this time, press the child safety seat with your own weight and push it into the vehicle seat.

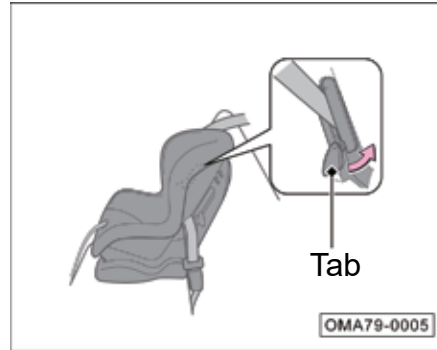

5. Place the seat belt correctly and push the tab up. Make sure the seat belt is not twisted. When pushing the tab up, pull upward the upper part of the shoulder belt to tension the belt.



6. Shake the child safety seat back and forth, left and right to make sure it is firmly fixed.
7. Make sure that all unused seat belts in the reach of the children are locked.

3. Instructions for safe operation

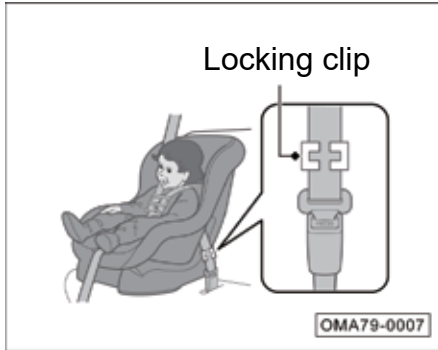

If no means are provided on the child safety seat for securing the seat belt, please install a tongue on the seat belt.

- After the above steps 1 and 2, pull up the shoulder belt and make sure the lap belt is tensioned.
- Firmly grasp the seat belt near the tongue. Pinch the two parts of the seat belt together so that they do not slip out of the tongue. Unbuckle the seat belt.

Install the locking clip as shown. Place the buckle as close as possible to the locking tab and insert the locking tab into the locking clip. Go to steps 6 and 7.

Installing ISOFIX System

The 2nd-row seats of this vehicle are equipped with the ISOFIX system. The following are installation instructions for ISOFIX child safety seats.

⚠ WARNING

- **The child safety seat anchorages installed in this vehicle can be used to fix the child safety seats only.**
- **Do not connect straps, hard and sharp objects or any other objects to the anchorages; otherwise children may be endangered in the event of an accident.**

2nd-row seats



The front anchorage ① of the 2nd-row seat is hidden in the cushion gap.

3. Instructions for safe operation



i NOTE

The rear anchorage ② of the 2nd-row seat is hidden at the rear of the seat back, which can be found by opening the gap of seat back cover.

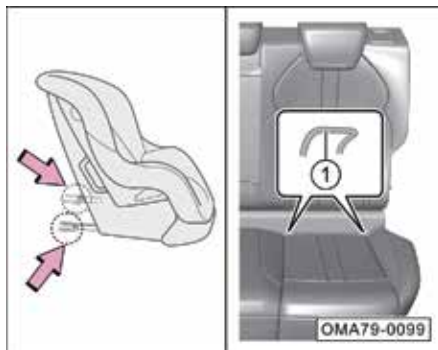

1. Put the child safety seat on the seat, find the front anchorage ①, and insert the lower guide groove of the child safety seat as arrowed into the front anchorage ① until a click sound is heard.

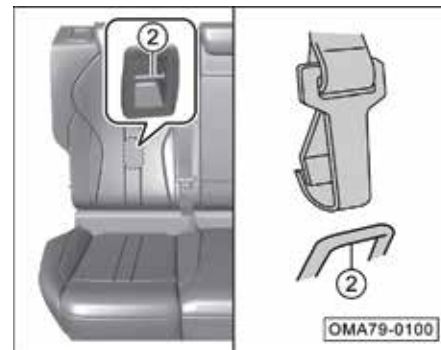

2. Thread the strap through the top of seat back, find the top anchorage ②, and attach the strap hook to the top anchorage ② with the strap not twisted.
3. Tension the strap and shake the child safety seat to ensure it is firmly fixed.

3.5 Exhaust gas hazard

Carbon monoxide

The exhaust gas emitted by the engine contains the toxic carbon monoxide gas. Please use the vehicle correctly to prevent the carbon monoxide gas from entering the vehicle.

Please contact the GAC Motor authorized shop to check whether the exhaust system is normal in the following cases:

- The exhaust system makes abnormal noises.
- The exhaust color is abnormal.

If the engine is idling during parking, please open all the windows and turn on the A/C system:

1. Select the fresh air mode.
2. Select  mode.
3. Set the fan speed to the maximum.



WARNING

- **Carbon monoxide gas is toxic, and inhaling a great quantity of it will cause loss of consciousness and even death.**
- **When the engine is started for a long time in a confined space (such as a garage, etc.), carbon monoxide will quickly accumulate, resulting in excessive carbon monoxide in the vehicle. After starting the engine, drive the vehicle away from the confined space immediately.**

3. Instructions for safe operation

3.6 Safety label

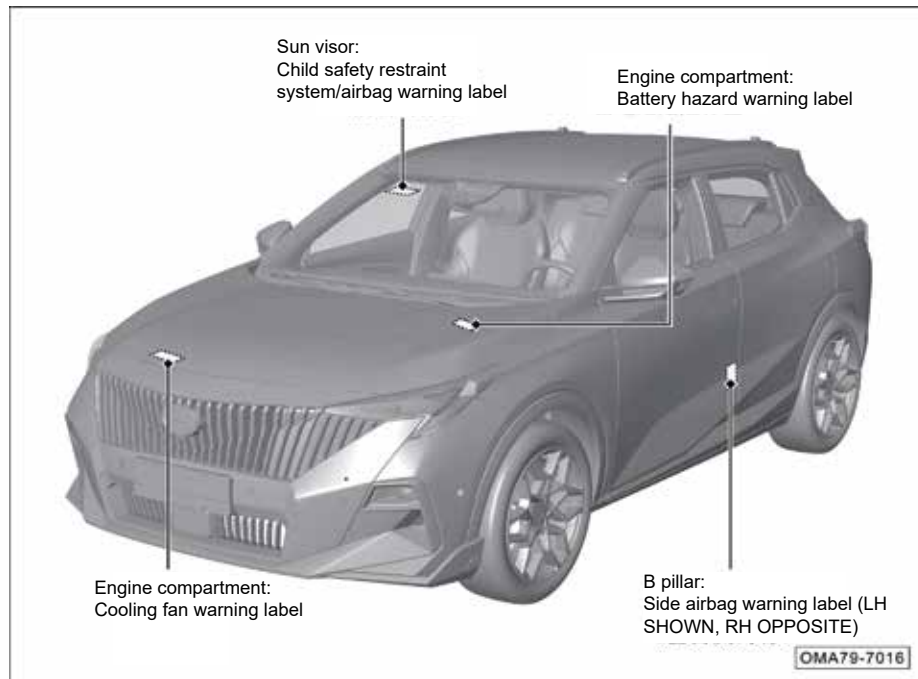

The labels are located as shown to remind you of the potential danger that can cause serious injury or death. Please read these labels carefully.

If the label comes off or is difficult to read, please go to the GAC Motor authorized shop in time for replacement.

i NOTE

In case of any discrepancy in the illustrated location or quantity of the labels, the actual vehicle shall prevail.

4. Operation of systems and equipment

4.1 Cab

4.1.1 Steering wheel

Adjustment of the steering wheel position



- Adjust the driver's seat to a suitable position, so that the distance between the steering wheel and your chest is not less than 25cm.



- Push down the locking handle ① to unlock the steering wheel.
- Adjust the steering wheel to the appropriate position up, down, front, and back as required, so that you can see the instrument panel and all indicator lamps.
- Pull up the locking handle ① to lock the steering wheel and make sure it is firmly locked.

⚠ CAUTION

If a great locking force is applied for locking the locking handle, you can release the locking handle again and then shake it up and down for locking again.

⚠ WARNING

- During driving, the driver's hands should always grasp the outer ring of the steering wheel (9 o'clock and 3 o'clock positions).
- After adjustment, the steering wheel must be locked to prevent shifting while the vehicle is running.
- Only when the vehicle is stopped can the steering wheel be adjusted to avoid traffic accidents.
- To ensure safety, the steering wheel should face your chest, otherwise the airbag cannot provide effective protection in the event of an accident.

4. Operation of systems and equipment

Buttons on steering wheel



- ① Horn button: Press  button to sound the horn; release the button to stop sounding the horn.

WARNING

Do not press and hold the  button for a long time; otherwise the horn is highly prone to be damaged.

- ② AV system control button => See page 113
- Voice button => See page 113
 - Custom button* => See page 114
 - Exhaust sound button* => See page 134
- ③ The left buttons include the control buttons of the instrument cluster display and the cruise control buttons:
- Control buttons of the instrument cluster display
 - Instrument cluster theme switching => See page 40
 - Driving information => See page 40
 - Alarm message => See page 42
 - Cruise control button:
 - Cruise control button* => See page 148
 - ACC button => See page 150
 - Integrated cruise control button => See page 160

4. Operation of systems and equipment

4.1.2 Instrument cluster

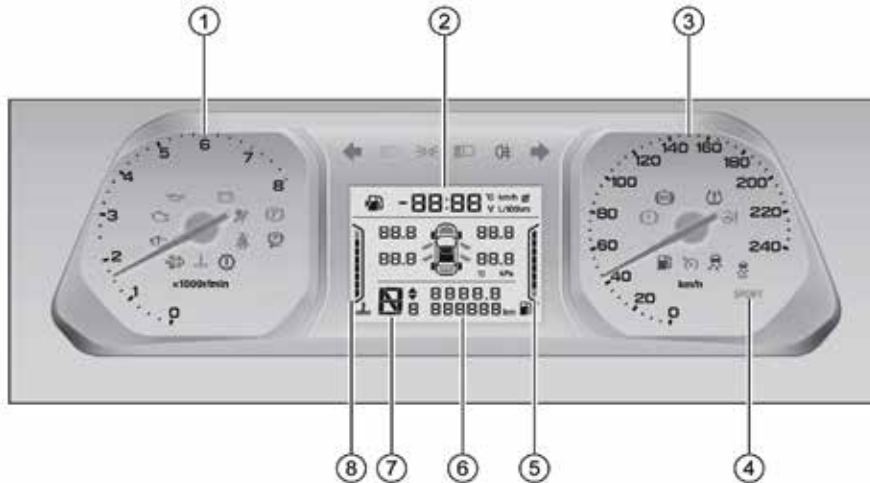

3.5 inch instrument cluster*

- ① Tachometer
- ② Driving information display
- ③ Speedometer
- ④ Driving mode
- ⑤ Fuel gauge
- ⑥ Mileage display
- ⑦ Gear display
- ⑧ Engine coolant temperature gauge

OMA79-0048

4. Operation of systems and equipment

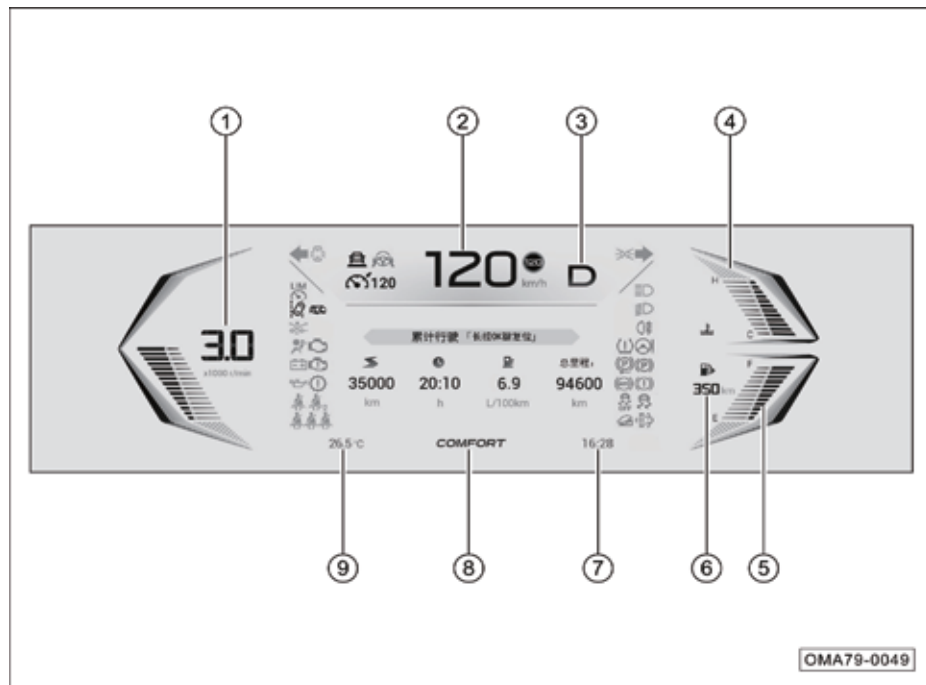

7-inch instrument cluster*(organic theme)

- ① Tachometer
- ② Vehicle speed display
- ③ Gear display
- ④ Engine coolant temperature gauge
- ⑤ Fuel gauge
- ⑥ Range
- ⑦ Time display
- ⑧ Driving mode
- ⑨ Outside temperature indication

i NOTE

The theme of 7-inch instrument cluster includes “organic theme” and “minimalist theme”. The “organic theme” is illustrated here and for reference only. Please refer to the actual vehicle.

4. Operation of systems and equipment

Tachometer

The tachometer is used to indicate the current engine speed, in 1,000 r/min.

CAUTION

The area of 6000~8000 r/min represents the high load area of the vehicle. Avoid running the vehicle with the pointer of the tachometer within this area; otherwise, fuel shut-off and loss of power will occur due to self-protection of the engine.

Speedometer

The speedometer indicates the current speed of the vehicle in km/h, in the range of 0~240 km/h.

WARNING

For driving safety, please strictly abide by the traffic rules, and never speed the vehicle.

Engine coolant temperature gauge

The engine coolant temperature gauge is used to indicate the current temperature of the engine coolant.

- The indication range covers C~H, where, "C" means low temperature and "H" means high temperature.

After the engine is started, the corresponding scale divisions of the coolant temperature gauge will be illuminated according to different temperatures, and the engine operating temperature will vary depending on the ambient temperature and engine load.

- Conditions where the gauge indicates high coolant temperature: prolonged climbing in hot weather; deceleration or stop after driving at a high speed; in areas with heavy traffic, where the HVAC system is turned on and the engine idles for a long time; towing, etc.
- Conditions where the gauge indicates low coolant temperature: insufficient warm-up after cold start in cold weather; running with maximum heating in cold weather, etc.

Fuel gauge

The fuel gauge is used to indicate the current amount of fuel remaining in the fuel tank.

- The indication range is E~F, where "E" means the fuel tank is empty, and "F" means the fuel tank is full. The corresponding scale divisions are illuminated according to the remaining fuel in the fuel tank.
- When there is no bar or only the first bar is illuminated, it indicates that there is insufficient fuel in the fuel tank. In such case, the  indicator lamp on the instrument cluster flashes in yellow, and a text message will pop up to remind the driver to refuel in a timely manner.

Gear display

- The current gear information of the vehicle such as "P", "R", "N", "D" or "S" is displayed according to the received signal.

Driving mode

- The current driving mode of the vehicle is displayed according to the received signal.

4. Operation of systems and equipment

Outside temperature indication

- The current outside temperature is displayed.

Odometer

- The odometer indicates the traveled distance of the vehicle in the driving information screen.
- The indication range is 0~999999 km.

Instrument cluster display

The display information includes: driving information, vehicle condition, ADAS*, alarm center*, phone information*, audio entertainment information*.

CAUTION

If the instrument cluster display is abnormal, stop the vehicle immediately for the sake of safety, and contact the GAC Motor authorized shop for inspection.

Instrument theme switching*



With the START/STOP button in "ON" position, press "VIEW" button on the left of steering wheel to switch instrument panel theme.

- Pressing the "VIEW" button can make the 7-inch instrument cluster to switch between the organic theme minimalism theme freely.

Driving information

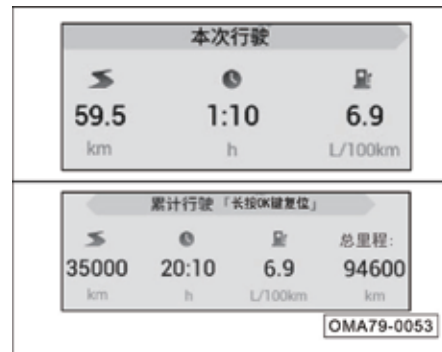

When the START/STOP button is set to "ON" position, move up or down the "OK" button on the left of the steering wheel to switch to the driving information interface.

- The driving information interface includes: Current mileage, cumulative mileage, and total mileage.
- Current mileage: Refers to the driving information (current mileage/driving time/average fuel consumption) within a single trip of the vehicle after the START/STOP button is turned on. This parameter cannot be reset.

4. Operation of systems and equipment

- Cumulative mileage: Refers to the driving information (cumulative mileage/ driving time/average fuel consumption/ total mileage) of the vehicle since the last reset. Other parameters except for the total mileage can be reset by pressing and holding the “OK” button.

i NOTE

The organic theme of 7-inch instrument cluster is illustrated here and for reference only. Please refer to the actual vehicle.

Vehicle state

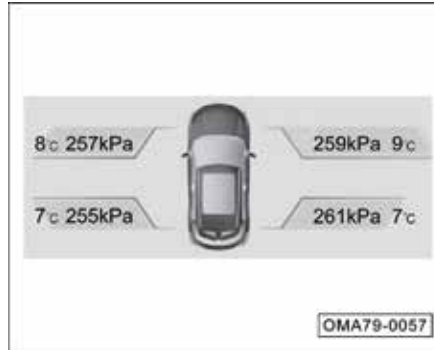

When the vehicle power switch is set to “ON” position, move up or down the “OK” button on the left of the steering wheel to view the vehicle state.

- The displayed information includes tire pressure, tire temperature, door state, and seat belt alarm message.
- When tire pressure is abnormal, any door/ liftgate/engine hood is ajar or any seat belt is unfastened, the screen will pop out automatically.

i NOTE

The organic theme of 7-inch instrument cluster is illustrated here and for reference only. Please refer to the actual vehicle.

4. Operation of systems and equipment

ADAS*



This interface displays the current status of driving assist.

i NOTE

The organic theme of 7-inch instrument cluster is illustrated here and for reference only. Please refer to the actual vehicle.

Alarm center*



On the alarm center screen, the current state of the vehicle is displayed in the form of texts or pictures. The driver should always pay attention to checking for alarm message.

- If the vehicle is in normal condition, no alarm message is displayed.
- If the vehicle is faulty or certain function is activated/deactivated, corresponding text or picture message will appear at the bottom of the instrument cluster screen, reminding the driver about the current state of the vehicle.

- After the alarm message pops up, press the "OK" button on the left of the steering wheel to confirm, and the alarm message will enter the alarm center. Some important alarm messages will pop up again on the instrument cluster a few seconds later; The disarmed alarm will be automatically cleared in the alarm center. In case of an alarm in the alarm center, it cannot be cleared by the driver.

i NOTE

The organic theme of 7-inch instrument cluster is illustrated here and for reference only. Please refer to the actual vehicle.

AV and entertainment information *



- This interface will only be displayed when the multimedia function such as radio and music is turned on, otherwise it will be hidden.

i NOTE

The organic theme of 7-inch instrument cluster is illustrated here and for reference only. Please refer to the actual vehicle.

Call information*









- When the AV system is connected to the Bluetooth of mobile phone, the currently accessed phone number will be displayed at the bottom of the instrument cluster display, and the call time will be displayed in case of answering a call.

Setting of instrument panel











With the START/STOP button set to "ON" position and the position lamp on, the instrument cluster can be set by clicking "Settings→ Screen Settings → Instrument Display".

4. Operation of systems and equipment











4.1.3 Indicator lamp

No.	Icon	Designation	Color	Function
1		Charging system warning lamp	Red	When the START/STOP button is set to "ON" position and the engine is not started, the warning lamp lights up; if the engine is started, the warning lamp shall go out.
				If this warning lamp comes on after the engine is started, it indicates that the charging system is faulty.
2		Malfunction indicator lamp	Yellow	When the START/STOP button is set to "ON" position and the engine is not started, the indicator lamp will light up in case of no fault for a few seconds until the system completes the self-test.
				If this indicator lamp comes on after the engine is started, it indicates that the engine system is faulty.
3		Low oil pressure warning lamp	Red	When the START/STOP button is set to "ON" position and the engine is not started, the warning lamp lights up; if the engine is started, the warning lamp shall go out.
				If this warning lamp comes on after the engine is started, it indicates that the engine oil pressure is low.
4		Emission fault indicator lamp	Yellow	When the START/STOP button is set to "ON" position and the engine is not started, the indicator lamp will light up; if the engine is started, the indicator lamp shall go out.
				If this indicator lamp comes on after the engine is started, it indicates that the exhaust system is faulty.
5		Left turn signal indicator lamp and hazard warning lamp	Green	When the left turn signal indicator lamp flashes alone, it indicates that the left turn signal lamp of the vehicle is on.
				When the hazard warning lamp switch is pressed, the left/right/ turn signal indicator lamps and all turn signal lamps will flash simultaneously.
6		High engine coolant temperature indicator lamp	Red	If the red indicator lamp comes on, it indicates that the engine coolant temperature is too high.
7		Supplemental restraint system (SRS) indicator lamp	Red	If the red indicator lamp comes on, it indicates that the SRS system is faulty.
8		Low fuel level indicator lamp	Yellow	If the yellow indicator lamp flashes, it indicates that the fuel level of the fuel tank is low.
				If the yellow indicator lamp comes on, it indicates that the fuel pump level sensor circuit is faulty.









4. Operation of systems and equipment

No.	Icon	Designation	Color	Function
9		Right turn signal indicator lamp and hazard warning lamp	Green	If the right turn signal indicator lamp flashes alone, it indicates that the right turn signal lamp of the vehicle is on. When the hazard warning lamp switch is pressed, the left/right/ turn signal indicator lamps and all turn signal lamps will flash simultaneously.
10		EPB (EPB) status indicator lamp	Red	If the red indicator lamp comes on, it indicates that the EPB is applied.
			Green	If the green indicator lamp comes on, it indicates that the EPB is activated.
11		EPB (EPB) fault indicator lamp	Yellow	If the yellow indicator lamp comes on, it indicates that the EPB is faulty.
				If the yellow indicator lamp flashes, it indicates that the EPB is in the service mode.
12		Brake system indicator lamp	Red	If the red indicator lamp comes on, it indicates that the brake fluid level is too low or the electronic brake force distribution (EBD) system is faulty.
13		Electronic stability program (ESP) indicator lamp	Yellow	If the yellow indicator lamp comes on, it indicates that the ESP (ESP) is faulty.
				If the yellow indicator lamp flashes, it indicates that the ESP (ESP) is working.
14		ESPOFF indicator lamp	Yellow	If the yellow indicator lamp comes on, it indicates that the ESP (ESP) is off.
15		ABS (ABS) indicator lamp	Yellow	If the yellow indicator lamp comes on, it indicates that the ABS (ABS) is faulty.
16		Transmission fault indicator lamp	Yellow	If the yellow indicator lamp comes on, it indicates that the transmission system is faulty.
				If the yellow indicator lamp flashes, it indicates that the transmission fluid temperature is high.
17		TPMS (TPMS) indicator lamp	Yellow	If the yellow indicator lamp comes on, it indicates that the TPMS(TPMS) is faulty.
18		Electric power steering (EPS) indicator lamp	Red	If the yellow indicator lamp comes on, it indicates that the EPS (EPS) system is faulty.
19		IHC indicator lamp*	White	If the white indicator lamp comes on, it indicates that the intelligent high beam is in standby state.
			Blue	If the blue indicator lamp comes on, it indicates that the intelligent high beam is activated.

4. Operation of systems and equipment

No.	Icon	Designation	Color	Function
20		ACC indicator lamp indicating no vehicle * ahead	White	If the indicator lamp comes on in white, it indicates that the ACC is in the ready state, and there is no target vehicle ahead.
			Blue	If the blue indicator lamp comes on, it indicates that the ACC system is working, and there is no target vehicle ahead.
21		ACC indicator lamp indicating a vehicle * ahead	White	If the indicator lamp comes on in white, it indicates that the ACC is in the inhibited or ready state, and there is a target vehicle ahead.
			Blue	If the blue indicator lamp comes on, it indicates that the ACC system is working, and there is a target vehicle ahead.
22		ACC fault indicator lamp*	Yellow	If the yellow indicator lamp comes on, it indicates that the ACC system is faulty.
23		LDW status indicator lamp *	White	If the white indicator lamp comes on, it indicates that the LDW system is activated.
			Yellow	If the yellow indicator lamp comes on, it indicates that the LDW is faulty. In that case, please go to the GAC Motor authorized shop for inspection in time.
			Blue	If the blue indicator lamp comes on, it indicates that the LDW system is working normally or intervenes with the steering wheel for deviation correction.
24		FCW status indicator lamp*	Yellow	If the yellow indicator lamp comes on, it indicates that the FCW is faulty. In that case, please go to the GAC Motor authorized shop for inspection in time.
			Red	If the red indicator lamp flashes, it indicates that the FCWS is being triggered and activated.
25		Front passenger's seat belt indicator lamp	Red	If the red indicator lamp comes on, it indicates that the front passenger's seat belt is not fastened or the system is faulty.
26		Driver's seat belt indicator lamp	Red	If the red indicator lamp comes on, it indicates that the driver's seat belt is not fastened or the seat belt system is faulty.
27		High beam indicator lamp	Blue	If the blue indicator lamp comes on, it indicates that the high beam is on.
28		Position lamp indicator lamp	Green	If the green indicator lamp comes on, it indicates that the position lamp, instrument panel lamp, license plate lamp, etc. are on.
29		Rear fog lamp indicator lamp	Yellow	If the yellow indicator lamp comes on, it indicates that the rear fog lamp is on.

4. Operation of systems and equipment

No.	Icon	Designation	Color	Function
30		Cruise control indicator lamp *	White	If the white indicator lamp comes on, it indicates that the cruise control is in the ready state.
			Green	If the green indicator lamp comes on, it indicates that the cruise control is activated.
31		Hill descent control (HDC) indicator lamp*	Yellow	If the yellow indicator lamp comes, it indicates that the HDC system is activated.
32		Hands-on indicator lamp*	Blue	If the blue indicator lamp comes on, it indicates that hands on steering wheel is detected by ICA.
			Red	If the red indicator lamp comes on, it indicates that hands off steering wheel is detected by ICA.
33		Lateral control status indicator lamp*	White	If the indicator lamp comes on in white, it indicates that the ICA is in standby mode.
			Blue	If the indicator lamp comes on in blue, it indicates that the ICA is active.
			Yellow	If the indicator lamp comes on in yellow, it indicates that there is a fault with ICA.
34		2nd-row seat belt indicator lamp*	White	If the white indicator lamp comes on, it indicates that the corresponding 2nd-row seat belt is fastened.
			Red	If the red indicator lamp comes on, it indicates that the 2nd-row seat belt is not fastened or the seat belt system is faulty.
35		Door ajar indicator lamp	Red	If the red indicator lamp comes on, it indicates that the engine hood, one of the doors or liftgate is not closed.
36		Gasoline particulate filter (GPF) indicator lamp	White	If the white indicator lamp comes on, it indicates that the accumulated carbon of the GPF exceeds a certain limit , and it is necessary to run at a high speed for more than 40 minutes to clean the carbon automatically.
			Yellow	If the indicator lamp comes on in yellow, it indicates that the accumulated carbon of the GPF is excessive , and it is necessary to run at a high speed for more than 40 minutes to clean up the carbon automatically.
37		Exhaust sound indicator lamp*	White	If the indicator lamp comes on in white, it indicates that the exhaust sound system is active.
			Yellow	If the indicator lamp comes on in yellow, it indicates that there is a fault with the exhaust sound system.

Note: If any indicator or warning lamp on the instrument cluster comes on after the vehicle is started or during driving, it indicates that the related system or function is in a certain working state or faulty. Therefore, you should read carefully and understand the meaning of each indicator or warning lamp. In case of a fault, please go to or contact the GAC Motor authorized shop for inspection in time.

4. Operation of systems and equipment

4.2 Vehicle locking and unlocking

4.2.1 Remote control key

This vehicle is accompanied with two intelligent remote control keys (including emergency mechanical key) and the corresponding key barcodes. If the key needs to be re-customized, please inform the GAC Motor authorized shop of the key barcode. If the key barcode is missing, please inform the GAC Motor authorized shop of the VIN.

NOTE

After the engine is started, do not place the remote control key on the instrument panel under the front windshield, otherwise the prompt "No key detected" may appear.

Poor signal strength of remote control key

The operation of the remote control key button may be interfered or unstable in the following cases:

- Nearby equipment is emitting strong radio waves.

- The remote control key is carried together with telecommunication equipment, laptop, mobile phone, access control card or wireless signal transmitter.
- The remote control key is put together with magnetic cards (such as bank card and bus card).
- Metal objects contact or cover the remote control key.

CAUTION

The remote control key contains an electronic circuit that can trigger the engine immobilizer system. If the circuit is damaged, the engine may not be started. Therefore,

- Avoid placing the remote control key in direct sunlight or in a high-temperature or humid place.
- Avoid dropping the remote control key from a high place or crushing it by heavy objects.
- Avoid exposing the remote control key to any liquid. If the key gets wet accidentally, dry it immediately.

NOTE

- The buttons of the remote control key do not work when the START/STOP button is set to "ACC" or "ON" position.
- If the unlocking or locking function of the remote control key is deactivated, you can try to press the buttons on the remote control key 3 times continuously to activate the function.

Liftgate unlocking button



- ① : Locking button
- ② : Unlocking button
- ③ : Liftgate unlocking button
- ④ : ENGINE START/STOP button

① Button operations

- When this button is pressed once within the effective range, all doors will be locked; When this button is pressed and held, four door windows, sunroof* and sunshade* will be automatically closed; In the automatic closing process of windows, sunroof and sunshade, if the button is released, the windows, sunroof and sunshade will stop the action.
- If this button is pressed twice continuously, the vehicle locating function will be realized and the turn signal lamps will flash many times quickly.

CAUTION

Before closing the windows or the sunroof* by the remote control key, make sure that there are no body parts (such as head and hands) in the movement path of the windows or the sunroof so as to prevent a risk of pinch injury.

NOTE

- When the doors are locked, the turn signal lamps will flash once and the horn will sound once. The horn prompt can be activated or deactivated via "Settings → Sound Effect Settings → System Sound Effect → Unlocking/Locking Horn" on the AV system display.
- The locking-sensitive window closing can be activated or deactivated by selecting "Settings → Body Accessories → Door Window Lock → Locking-sensitive Window Closing" on the AV system display for some vehicle models. If this button is pressed once within the effective range after activation, all doors will be locked, and all windows and the sunroof will be closed automatically.

4. Operation of systems and equipment

② Button operations

- When this button is pressed once within the effective range, all doors will be unlocked; When this button is pressed and held, the sunroof will automatically tilt up; If the button is released in the process of window opening, the window will stop the action.

CAUTION

Press the unlock button  on the remote control key to unlock the door. If the door is not opened within approximately 30 seconds, the system will lock the door again.



NOTE

- When the doors are unlocked, the turn signal lamps will flash twice and the horn will sound twice. The horn prompt can be activated or deactivated via "Settings → Sound Effect Settings → System Sound Effect → Unlocking/Locking Horn" on the AV system display.
- Set via "Settings → Body Accessories → Door Window Lock → Remote Unlocking" in the AV system. Press the button  to unlock all doors or the driver's door only.

③ Button operations



- If the vehicle is provided with a power liftgate, double-clicking this button within the effective range can open the liftgate electrically. If you press this button again during the opening process, the liftgate will stop at the current position.
- If the vehicle is provided with a non power liftgate, double-clicking this button within the effective range can unlock the liftgate, which then can be opened manually.

④ Button operations

- Press the  button once within the effective range and hold the  button for about 5s until the turn signal lamp flashes. At this time, the engine can be started remotely.
- When the engine has been remotely started, press and hold the  button for about 3s to remotely shut down the engine.

4. Operation of systems and equipment

i NOTE

- Before remotely shutting down the engine, please confirm that the vehicle is in a locked state. If it is not possible to confirm whether the vehicle is in a locked state, please press the  button once and then hold the  button to shut down the engine.
- At the time of remotely starting the engine, please keep it within the effective range, otherwise unlocking may be triggered and the start may fail.
- The maximum holding time for remote start is 30 minutes by default. If you need to change the time, please go to the GAC Motor authorized shop to change it.

Battery replacement



Each time you press the buttons on the remote control key, the indicator lamp of the key will flash once. If the indicator lamp fails to flash, or you need to press the buttons several times to lock or unlock the doors, the battery may be exhausted or about to run out. It is recommended to go to the GAC Motor authorized shop for the battery replacement.

CAUTION

- Be sure to replace with a new battery of the same model as the old one.
- An inappropriate battery may damage the remote control key.
- Always comply with relevant environmental regulations to dispose the exhausted battery.

Battery replacement steps



- Press the locking button  and pull out the emergency mechanical key  as arrowed.

4. Operation of systems and equipment

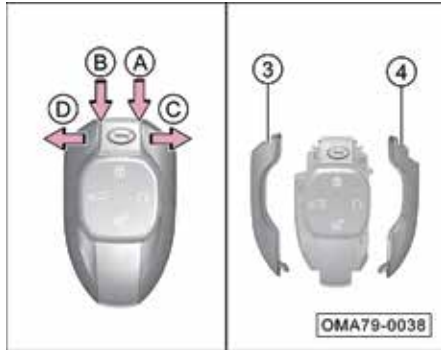

- Use a slotted screwdriver wrapped by cloth to pry open the chrome plated housing of the remote control key at positions (arrows A and B) in the direction of arrows C and D.
- Take off the chrome plated housings ③ and ④ of the remote control key.



- Take off the transparent trim cover ⑤.
- Use a slotted screwdriver wrapped by cloth to pry open the housing of the remote control key at arrow E.
- Take out the remote control key battery ⑥.
- Assemble the remote control key in the reverse steps mentioned above.

4.2.2 Emergency mechanical key

Emergency mechanical key





- Press the locking button ① and remove the emergency mechanical key ② as arrowed.

4.2.3 Door lock system

Central locking button



The central locking button ① can be used to lock and unlock the doors in the vehicle:

- Locking doors: Press the  end of the central locking button ① to lock all doors.
- Unlocking doors: Press the  end of the central locking button ① to unlock all doors.

Door inside handle



- If the vehicle is locked, pull the inside handle of any door once to unlock that door only; pull the inside handle of that door again to open that door.
- If the vehicle is unlocked, pull any door handle once to open the door directly.

NOTE

When the child safety lock is activated (=> See page 55), even if the rear door latch is unlocked, the rear door cannot be opened by operating the inside handle. In this case, the rear door shall be opened from outside. And do not pull the inside handle with force to avoid damages.

CAUTION

- Before driving the vehicle, make sure that all doors are properly closed and locked.
- Do not pull the door handle while driving to avoid accidents caused by door opening.
- When opening or closing the door, check the surroundings of the vehicle, such as whether the vehicle is on a slope, whether there is enough space to open the door or whether there is strong wind. When opening or closing the door, please firmly hold the door handle to prepare for any unpredictable movement.

4. Operation of systems and equipment

Door lock hole

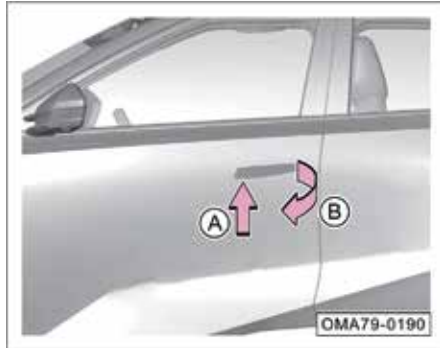

- Take out the emergency mechanical key.
=> See page 52
- Press the left side of the door handle as indicated by arrow A to make the right side of the door handle pop up, and then pull out the door handle at a certain angle as indicated by arrow B.

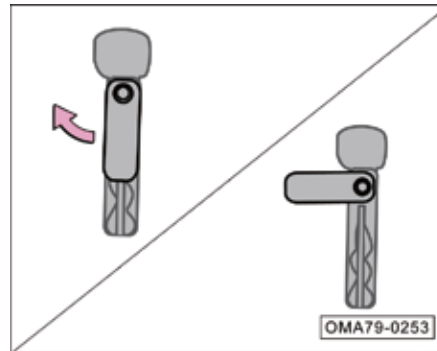

- Deploy the mechanical key handle.

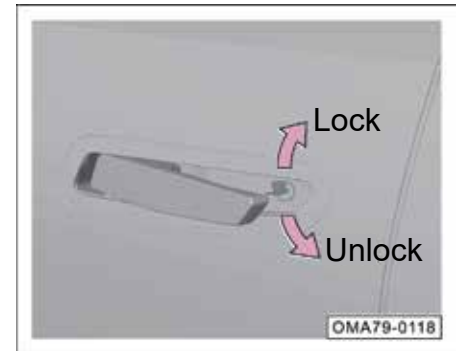

- Insert the emergency mechanical key into the driver's door lock hole.
- Pull up the mechanical key handle clockwise to lock all doors.
- Press down the mechanical key handle counterclockwise to unlock all doors.

Child safety lock

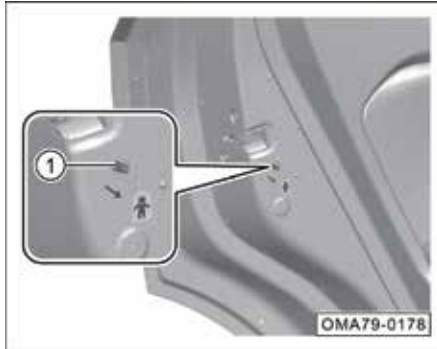

- Activate: Turn the child safety lock switch ① to the lock position as arrowed to activate the child safety lock.
- Deactivate: Turn the child safety lock switch ① to the unlocking position in the opposite direction of the arrow to deactivate the child safety lock.

i NOTE

- Before driving the vehicle, if any child sits in the rear seat, make sure that the child safety lock is activated.
- When the child safety lock is activated, the rear door cannot be opened by operating the handle. In this case, the rear door shall be opened from outside. And do not pull the inside handle with force to avoid damage.

⚠ WARNING

When the child safety lock is activated, never leave children or handicapped persons in the vehicle alone. Once the doors are locked, it is difficult for children or handicapped persons to leave the vehicle in an emergency; locked doors in an accident will make it more difficult to rescue persons inside the vehicle.

Automatic unlock function

If the vehicle stops with the doors locked and the vehicle power switch set to "OFF" position, the four doors will be automatically unlocked.

i NOTE

The automatic unlock function can be activated or deactivated by selecting "Settings → Body Accessories → Door Window Lock → Auto Unlock" on the AV system display.

4. Operation of systems and equipment

Speed sensing door lock

If this function is activated with all doors closed, the vehicle will be automatically locked at certain vehicle speed or after certain driving time.

i NOTE

- This function is deactivated by default. Please read the relevant content above before activating it.
- Activation or deactivation can be set by selecting “Settings → Body Accessories → Door Window Lock → Speed-sensitive Lock” on the AV system display.

Collision unlock function

With doors locked and the vehicle power switch set to “ON” position, when the system detects that the vehicle has suffered a severe collision, all doors will be automatically unlocked. Depending on the impact force and impact range, the system may not work under extreme conditions.

Intelligent active unlock

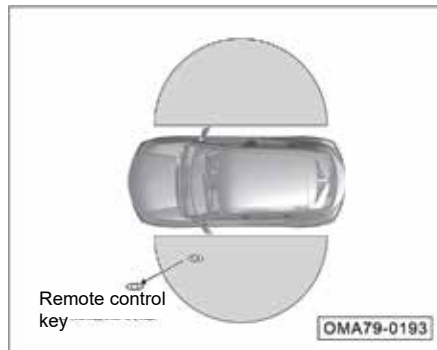

- When the intelligent active unlock function is activated and the intelligent remote control key is brought to the area within 1.2m of the vehicle, the vehicle will be automatically unlocked.

i NOTE

- This function can be activated or deactivated by selecting “Settings → Body Accessories → Door Window Lock → Intelligent Active Unlock” on the AV system display.
- If the intelligent active unlock is successful, the turn signal lamps will flash twice and the horn will sound twice.
- When the vehicle has been parked for more than 7 days, the intelligent active unlock will be turned off automatically to reduce the power consumption of the complete vehicle. At this time, unlocking can only be realized by the smart remote control key or the door handle induction. After the vehicle starts, the intelligent active unlock function will recover.

4. Operation of systems and equipment

Intelligent active lock

- With the intelligent active lock function activated and the START/STOP button set to "OFF" position, after all doors are closed, if the intelligent remote control key is taken away from the vehicle by users to an area within about 2m from the vehicle for more than 2min or to an area more than about 2m away from the vehicle, the vehicle will be automatically locked.
- If the key is kept from the vehicle within about 2 m for more than 2 minutes, the system will temporarily deactivate the intelligent active lock function for the purpose of power saving; the user needs to open and then close one of the doors to re-activate the intelligent active lock function.

NOTE

- This function can be activated or deactivated by selecting "Settings → Body Accessories → Door Window Lock → Intelligent Active Lock" on the AV system display.
- If the intelligent active lock is successful, the turn signal lamps will flash once and the horn will sound once.
- If the liftgate is not closed properly, an audible and visual alarm will be triggered after the successful intelligent active lock.

The intelligent active lock function will not be activated in case of the followings:

- the START/STOP button set to "ACC" or "ON" position.
- The intelligent remote control key is in the vehicle.
- No intelligent remote control key is detected within about 2m of the vehicle.
- The intelligent remote control key is thrown into the vehicle from the door window.
- The intelligent remote control key is in the trunk.
- Any door is not closed.
- The battery voltage is low.
- The PEPS antenna is faulty.

CAUTION

Do not leave children or handicapped persons in the vehicle alone when using the intelligent active lock function.

4. Operation of systems and equipment

4.2.4 Flush door handle



Once the vehicle is unlocked, the electric flush door handle will automatically deploy. Pull the door handle to open the door.

i NOTE

The electric flush door handle can be activated or deactivated by selecting "Settings → Body Accessories → Door Window Lock → Electric Flush Door Handle" on the AV system display. The door handle needs to be deployed manually after closing.

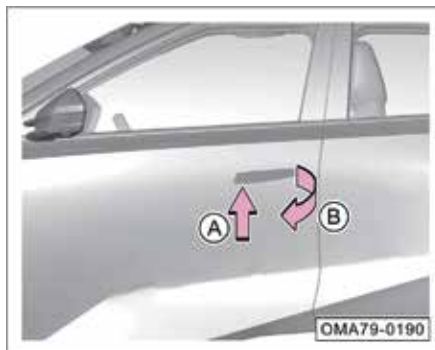

The door handle needs to be deployed manually if the electric flush door handle is set to be off. When the vehicle is unlocked, press the left side of the door handle as indicated by arrow A to make the right side of the handle pop up, and then pull the handle as indicated by arrow B to open the door. After releasing the door handle, it will automatically return to its flush position.

When using the flush door handle, please read and observe the following precautions:

CAUTION

For vehicle washing, please retract the flush door handle to avoid water entering the handle during the washing process, which may cause damage to the vehicle.

WARNING

Prevent hand pinching by door handle when locking the vehicle.

4. Operation of systems and equipment

Instruction for ice removal from flush door handle at low temperatures

When you approach the vehicle with the key, the vehicle will automatically detect the remote control key. At this point:

Method 1:

1. If a small amount of ice accumulates between the door handle and the door, the door handle can be electrically deployed. At this time, please press the remote control key to electrically open and close the door handle three times to remove residual ice.
2. If there is a lot of ice accumulation between the door handle and the door, the door handle cannot be electrically deployed. You can manually press the left side of the handle with force to make the tail end of the handle tilt up to remove the ice. In this way if the handle still cannot be electrically deployed, you need to manually deice according to the following operations:



- Lightly hit the circumference of the door handle with the bottom of your fist in a circular mode to break and remove the accumulated ice. Press the remote control key to electrically deploy the door handle.
- You can increase the intensity of hit as needed and repeat the above steps.

WARNING

When hitting the circumference of the door handle, please pay attention to controlling the force to avoid causing dents in the door sheet metal.

3. After the door handle can be moved, open and close it a few more times to remove residual ice and ensure that the door handle can be fully retracted in place.

Method 2:

Pour hot water to remove the ice.

4. Operation of systems and equipment

4.2.5 Door

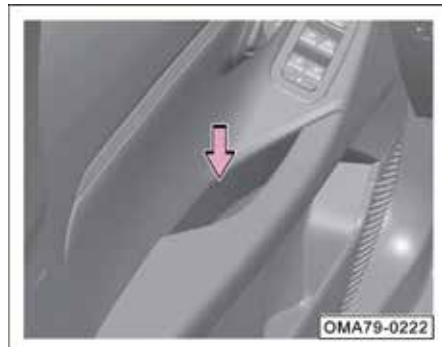

- In the vehicle, grab the door handle and pull it inward.
- To close the door outside, directly push the door inward.

CAUTION

Before opening the door, always pay attention to other vehicles or pedestrians outside the vehicle to avoid accidents caused by collision.

WARNING

- **Always ensure that all doors are closed to prevent suddenly opening during driving, which may cause personal injuries or accident.**
- **Open or close the doors only when the vehicle is stationary.**
- **Do not put your hands on the edge of the door when closing the door, otherwise there will be a risk of pinching.**

NOTE

- If the door is not closed properly, please re-open the door and close it again.
- If the door is not closed properly, there will be a corresponding indication on the instrument cluster display.

4.2.6 Liftgate

Unlocking liftgate with remote control key

If the vehicle is provided with a power liftgate, double-clicking the  button on the remote control key within the effective range can make the liftgate automatically open to the preset position. During opening, if you press this button again, the liftgate will stop opening.

If the vehicle is provided with a non power liftgate, double-clicking the  button on the remote control key within the effective range can unlock the liftgate, which then can be opened manually.

4. Operation of systems and equipment

Liftgate button operation

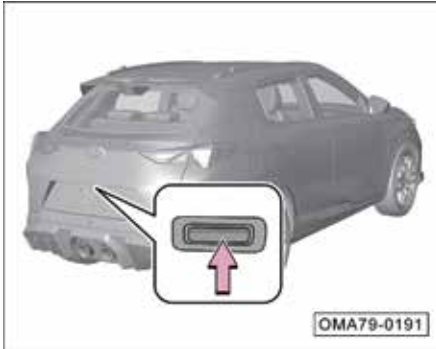

If you carry the intelligent remote control key, which is in the effective range, press the liftgate unlocking button to unlock the liftgate.

- If the vehicle is provided with a non power liftgate, the liftgate has to be opened manually.
- If the vehicle is provided with a power liftgate, the liftgate can automatically open to the preset position. During opening, if you press this button again, the liftgate will stop opening.

i NOTE

When the vehicle is unlocked and stationary, if you press the liftgate unlocking button directly without carrying the intelligent remote control key, the liftgate will also be unlocked and opened.

Operation of inside switch of liftgate*



- Press the inside button of the liftgate to electrically close the liftgate.
- In this process, press the inside button again to suspend opening/closing of the liftgate.

Setting of second height of liftgate:

When the height of opening of liftgate is 55%~98%, press and hold the inside button of liftgate for about 2 s to set the second height of liftgate successfully.

4. Operation of systems and equipment

CAUTION

The inside button of liftgate is a non-directional signal, and the liftgate confirms the relevant opening and closing direction according to the current state and the last movement direction. If last time the liftgate opening process was suspended, press the inside button next time and the liftgate will be closed; if last time the liftgate closing process was suspended, press the inside button next time and the liftgate will open.

Easy open of PLG *

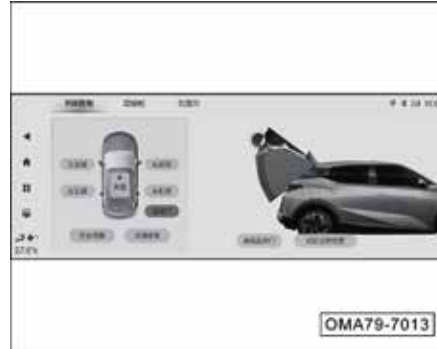

By clicking the 3D model in the intelligent scenic area on the main interface or selecting "My Car" in the application menu interface, you can enter the My Car interface.

- Click the soft key "Open liftgate" or "Close liftgate" to electrically open or close the liftgate.
- Drag the liftgate icon to set the target positions of 20%, 40%, 60%, 80% and 100%, and release the liftgate icon to allow the liftgate to move to the set target positions.

- In this process, drag the liftgate icon again to suspend opening of the liftgate.
- When the height of opening of liftgate is 55%~98%, click the soft key "Memorize current position" to set the second height of liftgate successfully.
- Click the soft key "Clear memory position" to clear the second height of liftgate successfully.

4. Operation of systems and equipment

Emergency opening of liftgate

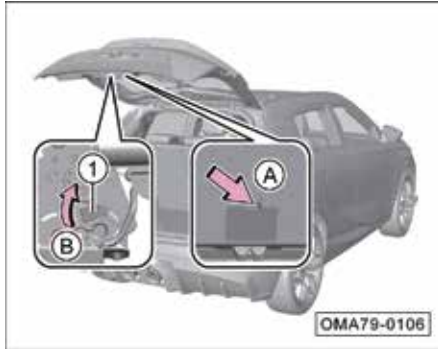

Applicable to PLG models:

When the vehicle is out of power or the liftgate fails to be opened normally, please try the emergency interior opening of liftgate:

1. Fold down the 2nd-row seat back. => See page 92
2. Open the trim panel on the liftgate at position (arrow A).
3. Move the liftgate emergency switch ① in the direction of arrow B for emergency unlocking and opening of the liftgate.

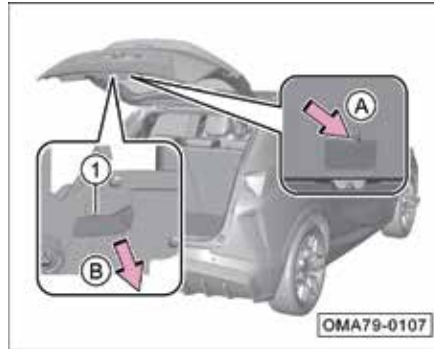

Applicable to non PLG models:

When the vehicle is out of power or the liftgate fails to be opened normally, please try the emergency interior opening of liftgate:

1. Fold down the 2nd-row seat back. => See page 92
2. Open the trim panel on the liftgate at position (arrow A).
3. Move the liftgate emergency switch ① in the direction of arrow B for emergency unlocking and opening of the liftgate.

Closing of liftgate



PLG closing*

- If you press the liftgate close button, the power liftgate will be automatically lowered until it is closed. In this case, if you press this button again during the closing process, the liftgate will stop at the current position.
- Within the operating range of the intelligent remote control key, if you press the button  on the key twice, the power liftgate will be automatically lowered until it is closed. In this case, if you press this button again during the closing process, the PLG will stop at the current position.

4. Operation of systems and equipment

Manual closing

When the electric opening and closing function of the liftgate is not applicable or fails, the liftgate may be closed manually:

- Lower the liftgate close to the rear bumper cover, and then press down the liftgate firmly with both hands to close it.



CAUTION

During closing of the liftgate, do not put your hands or any part of your body in the closing area of the liftgate so as to avoid pinch injury.

i NOTE

- When the liftgate is electrically closed from a stationary state, the turn signal lamps will flash twice and the buzzer will sound.
- When the power liftgate is closed electrically, the buzzer will sound intermittently.
- If the liftgate is not closed properly, there will be a corresponding indication on the instrument cluster display.

CAUTION

- Before driving, ensure that the liftgate is fully closed. If the liftgate is not fully closed, it may accidentally open and collide with nearby objects during driving, or the articles in the trunk may be thrown out, leading to accidents.
- Please do not allow children to play in the trunk. Otherwise, they may be locked in the trunk by accident and suffer heatstroke, suffocation or other injuries thereafter.
- Do not allow children to open or close the liftgate. Otherwise, it may cause the liftgate to accidentally open, or the children's hands, head, or neck may be caught by the liftgate being closed.
- During driving, do not allow anyone to sit in the trunk, as it may cause serious injury or even endanger life in case of emergency braking or collision.

4. Operation of systems and equipment

WARNING

- Before opening or closing the liftgate, please thoroughly check the surrounding area to ensure safety.
- Ensure that the liftgate is fully open and secured before using the trunk. Otherwise, the liftgate may suddenly close and pinch a certain part of your body, causing serious injury.
- Before opening the liftgate, all loads, such as snow and ice, should be removed from the liftgate. Otherwise, the opened liftgate may suddenly close and pinch a certain part of your body, causing serious injury.
- Do not add any accessories on the liftgate. Otherwise, the additional weight on the liftgate may cause it to suddenly close after opening and pinch a certain part of your body, causing serious injury.
- When closing the liftgate, be careful not to pinch fingers or other parts.

WARNING

For vehicles equipped with PLG, if the liftgate cannot be opened or closed electrically, please operate it manually and slowly. Do not exert brute force, otherwise it may cause damage or malfunction to the tailgate.

4.2.7 Engine hood

Opening of engine hood



- If the engine hood release handle ① is pulled, the engine hood will be unlocked and pop up slightly.

4. Operation of systems and equipment



- Push the locking mechanism ② as arrowed to unlock the engine hood fully.



- Lift the hood up to the limit position, take out the stay bar from the stay bar bracket ①, and fix the stay bar in the fixing hole ② to support the hood at the limit position.

Closing of engine hood

- Take out the stay bar from the fixing hole ② and place it on the stay bar bracket ①; Lower the hood to a height of about 30 cm away from the lock body, and then let go to allow the hood to fall freely and then be locked.

WARNING

- Before driving, make sure that the engine hood is completely closed and locked, otherwise, it may suddenly open and cause an accident during driving.
- If the engine hood is ajar, there will be a corresponding alarm message on the instrument cluster display; In this case, please stop driving immediately and close and lock the engine hood correctly.

4.2.8 Power window

The power window can either be operated with the START/STOP button set to the "ON" position or within approximately 30s after the START/STOP button is switched from the "ON" position to the "ACC" or "OFF" position. If the door is opened within approximately 30s, the power windows cannot be operated further.

CAUTION

- Please close all windows before leaving the vehicle.
- Do not put your hands on the edges of the windows when closing the windows, otherwise there will be a risk of pinching.

Driver's power window control button



- ① Left front power window control button
- ② Right front power window control button
- ③ Left rear power window button
- ④ Right rear power window button
- ⑤ Passenger's power window control button

- If the button ① is pulled up to the first stop position, the power window will be lifted for closing until the button is released or the window reaches the highest position.
- If the button ① is pulled up to the limit position, the power window will be lifted automatically for closing until the window reaches the highest position.
- If the button ① is pressed down to the first stop position, the power window will be lowered for opening until the button is released or the window reaches the lowest position.
- If the button ① is pressed down to the limit position, the power window will be lowered automatically for opening until the window reaches the lowest position.

NOTE

- If you want to stop the window during the automatic lifting or lowering, just press down/pull up the button ①.
- Buttons ②, ③ and ④ are operated in the same way as button ①, and control the corresponding door windows only.

4. Operation of systems and equipment

- If you press the passenger's window lock button ⑤, the button indicator lamp will come on and the front and rear passenger's power window control buttons cannot work anymore. If you press this button again, this function will be deactivated and the button indicator lamp will go out.

Passenger's power window control button



- For the operation methods of the passenger's power window control button ①, please refer to the driver's power window control button.

Locking-sensitive window closing function*

If the vehicle is locked with any window opened, the system will automatically close the window to prevent the vehicle from being damaged due to any opened window. This function can be activated or deactivated by selecting "Settings → Body Accessories → Door Window Lock → Locking-sensitive Window Closing" on the AV system display. If the window fails to be closed automatically due to abnormal conditions such as activation of anti-pinch function, the horn will sound 4 times to remind the user that the window closing fails.

CAUTION

The locking-sensitive window closing function is effective only when the battery SOC and relevant parts are normal. Do not leave the vehicle until it is confirmed that the windows are fully closed.

Automatic window calibration

If the window cannot be automatically lifted due to external factors, the window will first lower to the bottom for automatic calibration before automatic lifting.

CAUTION

Under special circumstances, an individual window may not be automatically lifted, and thus the window is required to be manually lifted for calibration.

Window open warning*

When the START/STOP button is turned to "OFF" position with any window open, if you open the driver's door, the system will send a buzzer sound and the instrument cluster display will display the warning message "Window open".

4. Operation of systems and equipment

Initialization of anti-pinch function

If the express-up function is not available, or the anti-pinch function fails, or the initialization becomes invalid automatically because the anti-pinch function is triggered multiple times in a short period of time, the power window needs to be initialized again.

1. Pull up the power window control button, and then the window is lifted in steps until it is completely closed.
2. After the window is completely closed, continue to pull up the power window control button and hold it for about 2s to complete the initialization.
3. After the initialization of the corresponding window, operate the window button to activate the express-down feature, and then continue to press the power window button and hold it for about 2 s, to enable the window to reach a hard stop.
4. Lift the power window button to check whether the express-up feature is available.

WARNING

- **If the window has no anti-pinch function during the initialization learning process, please do not use any part of your body or other objects to hinder the closing of the window, otherwise it will cause personal injury and affect the result of the initialization learning.**
- **If the power window system fails, please go to the GAC Motor authorized shop for inspection in time.**

4.2.9 Power sunroof*

The power sunroof can be operated when the START/STOP button is set to "ON" position; Within 30s after the START/STOP button is switched from the "ON" position to the "ACC" or "OFF" position, the power sunroof is still operable. If the door is opened in this period, the function will be deactivated automatically and the power sunroof cannot be operated further.

NOTE

When the ignition is in the "OFF" position with the power sunroof not closed and the driver's door opened, the instrument cluster will display the message "Sunroof Open" and send a buzzer sound; in this case, be sure to check whether the sunroof is closed.

CAUTION

Please close the sunroof, otherwise there will be a risk of water ingress on rainy days.

4. Operation of systems and equipment

Electric sunshade*



- To open the power sunshade slightly, press the button ①, and the sunshade will move for a short distance and then stop.
- To close the power sunshade slightly, press the button ②, and the sunshade will move for a short distance and then stop.

- If you want to fully open the power sunshade, press the switch ① for a certain period of time, and the power sunshade will automatically move to the fully open state.
- If you want to fully close the power sunshade, press the switch ② for a certain period of time, and the power sunshade will automatically move to the fully closed state.

i NOTE

If the switch is pressed during the automatic opening or closing of the electric sunshade, the electric sunshade will stop at the current position.

👁 CAUTION

Do not touch the sunshade with hand or object when it is opening or closing; otherwise, the sunshade may incur wrinkle, dislodgement or even failure.

Opening or closing of sunroof



- To open the sunroof slightly, push the sunroof switch ① backward, and then the sunroof will move in the opening direction for a short distance and then stop.
- To close the sunroof slightly, push the sunroof switch ① forward, and then the sunroof will move in the closing direction for a short distance and then stop.
- If you want to fully open the sunroof, push the sunroof switch ① backward and hold it for a short period of time, and the sunroof will move to the fully open position.

4. Operation of systems and equipment

- If you want to fully close the sunroof, push the sunroof switch ① forward and hold it for a short period of time, and the sunroof will automatically move to the fully closed position.

i NOTE

- When the sunroof is opened, the power sunshade will automatically open with the sunroof.
- When the sunroof automatically opens or closes, briefly push the sunroof switch ① forward or backward, and the sunroof will stop moving and stay in the current position.

Tilting of sunroof



- When the sunroof is fully closed, press the ↕ position of the sunroof switch ①, the sunshade will automatically open to a half open state, and the sunroof will tilt outward. Just push the sunroof switch ① forward to deactivate the tilting function.

Remote control

With the START/STOP button set to the "OFF" position, press and hold the ⏻ button on the remote control key, and the sunroof and sunshade will be remotely closed. Release the button, and the sunroof and sunshade will stop closing.

With the START/STOP button set to the "OFF" position, press and hold the ⏻ button on the remote control key, and the sunroof will be tilted remotely.

i NOTE

The remote control function only supports tilting and closing other than opening

4. Operation of systems and equipment

AV system display control



On the AV system screen, the sunroof or sunshade opening/closing can be controlled by clicking the "3D model" in the intelligent scenic area or the soft keys such as <, >, "Fresh air", "Sunshade fully open", and "Sunshade fully closed" in the application menu "My Car".

Power sunshade anti-pinch function

The power sunshade is provided with anti-pinch function for sliding to close, which can prevent the sunshade from catching large objects when closing.

- If the anti-pinch function is activated when the power sunshade is closed by sliding, the sunshade will move in the opening direction for a certain distance and then stop.

CAUTION

Do not operate the power sunshade when the ambient temperature is below -20°C , at which the anti-pinch function of the sunshade may not be activated, resulting in accidents. In addition, the low temperature will also damage the motor to a certain extent.

Anti-pinch function of sunroof

The anti-pinch function is available for the sliding closing and the downward tilting closing of the sunroof, and is to prevent large objects from being pinched when the sunroof is closed.

- If the anti-pinch function is activated when the sunroof is closed by sliding, the sunroof will move in the opening direction for a certain distance and then stop.
- If the anti-pinch function is activated when the sunroof is closed by tilting, the sunroof will move in the tilting direction until it reaches the maximum tilting position.

CAUTION

Do not operate the sunroof when the ambient temperature is below -20°C , at which the anti-pinch function of the sunroof may not be activated, resulting in accidents. In addition, the low temperature will also damage the motor to a certain extent.

4. Operation of systems and equipment

CAUTION

If the power window system fails, please go to the GAC Motor authorized shop for inspection in time.

WARNING

- The anti-pinch function of the sunroof or sunshade cannot prevent pinching of light or thin objects.
- When closing the sunroof or sunshade, be careful and make sure that no one is within the movement range of the sunroof or sunshade to avoid any pinching.
- The sunroof or sunshade will stop detecting obstacles at a position where the sunroof or sunshade is about to be closed fully, so the anti-pinch function will be deactivated at this time.
- Do not attempt to activate the anti-pinch function with your hands or any part of your body, you may be injured by a pinch.

Initialization of sunroof



In some cases (such as a sudden power failure of the battery or after the vehicle has not been operated for a long time), it may be necessary to manually perform initialization and self-learning of the sunroof. Specific operations are as follows:

- Press the switch ① to allow the sunroof moving to the fully closed position.
- Press and hold the switch ①, so that the sunroof will first run to the tilt position, then open for a certain distance, and finally run to the fully closed position.
- Release the switch ① to end the sunroof initialization.

Initialization of power sunshade



- Press the sunshade close switch ① to allow the sunshade moving to the fully closed position.
- Press and hold the sunshade close switch ①, so that the sunroof will first open for a certain distance, and then run to the fully closed position.
- Release the sunshade close switch ① to end the sunshade initialization.

4. Operation of systems and equipment

4.2.10 Basic operation of body anti-theft system

Body anti-theft function - remote control unlocking

When the ignition is in the "OFF" position and the vehicle is in the anti-theft state, if you bring the intelligent remote control key to approach the vehicle doors and press the UNLOCK button on the remote control key, all the doors will be unlocked to release the vehicle from the anti-theft state, and the turn signal lamps will flash twice.

Body anti-theft function - remote control locking

When the ignition is in the "OFF" position and the four doors, engine hood and liftgate are closed, if you take the intelligent remote control key away from the vehicle and press the locking button on the remote control key, all the doors will be locked to enable the vehicle to enter the anti-theft state, and the turn signal lamps will flash once.

Activation of body anti-theft function

When the ENGINE START/STOP button is in "OFF" position and the vehicle is armed, if the door is unlocked by an illegal key or is forcibly unlocked, the anti-theft system will be activated, the anti-theft horn will sound and the turn signal lamps will flash.

When the vehicle is locked by remote control to enter the anti-theft state, if the emergency mechanical key is used to unlock the driver's door, the anti-theft system will trigger the horn to sound and the turn signal lamps will flash.

i NOTE

Before or during the anti-theft alarm is triggered, if you press the  button on the remote control key or set the START/STOP button to the "ON" position, the anti-theft alarm will be disabled and the vehicle will be released from the anti-theft state; the alarm can be triggered up to 10 times in one cycle.

Engine immobilizer

When the START/STOP button is set from the "OFF" position to the "ON" position with the body anti-theft state released and the legal key in the vehicle, if the engine immobilizer system passes the verification, it will be deactivated.

If the engine immobilizer system does not pass the verification, the engine cannot be started and an immobilizer alarm will be triggered.

Body anti-theft maintenance instructions

No maintenance is required during normal use. If you have any doubt, please contact the GAC Motor authorized shop.

4.3 Lamps and vision

4.3.1 Exterior lamps

Lamp/light combination switch



- ① Lamp switch
- ② Fog lamp switch

i NOTE

The model with automatic lighting is illustrated here. For the specific function switches, please refer to the actual vehicle.

i NOTE

- Water vapors or even water drops may appear on the inner surfaces of the lamps under certain conditions (such as high air humidity and vehicle washing conditions), similar to the fogging phenomenon on the windows when the vehicle is traveling in the rain, but this is not a malfunction.
- This fogging phenomenon can be eliminated by parking the vehicle in a dry environment, turning on the lamps or driving the vehicle, but may recur.
- If there are a lot of water drops or water ingress in the lamps, please contact the GAC Motor authorized shop for inspection.

Turn signal lamp

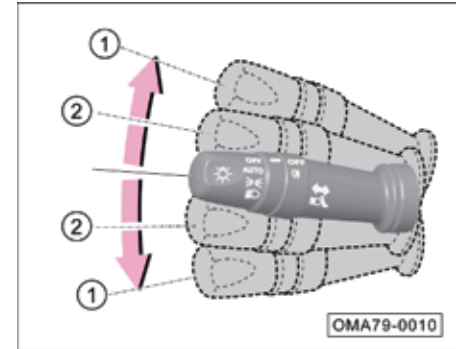

- With the START/STOP button set to “ON” position, turn the lamplight combination switch up or down to the limit position ① and then the corresponding indicator lamp \blacktriangleright or \blacktriangleleft on the instrument cluster will flash.

Turn signal lamp flashing for lane change

- In case of lane change or overtaking, if you rapidly turn the lamplight combination switch up or down to the position ② and then release it to the original position, the corresponding turn signal lamp and the indicator lamp \blacktriangleright or \blacktriangleleft on the instrument cluster will flash 3 times.

4. Operation of systems and equipment

- If you turn the lamplight combination switch up or down and hold it at the position ②, the corresponding turn signal lamp and the indicator lamp ➡ or ➡ on the instrument cluster will flash continuously. Releasing the switch to the original position can stop the flashing.

CAUTION

If the corresponding indicator lamp ➡ or ➡ on the instrument cluster flashes faster, one turn signal lamp may be faulty. In that case, please go to the GAC Motor authorized shop for inspection in time.

Lamp switch



When the START/STOP button is in the "ON" position, turn the lamplight control switch ① to turn on or off AUTO (automatic headlamp on/off function)*, P.L. (position lamp), and L.B. (low beam).

When the lamplight switch is turned to the "OFF" position, all lamps will go out.

AUTO (automatic headlamp on/off function)*

- Turn the lamplight switch to the AUTO position to activate the automatic headlamp on/off function.

NOTE

If the automatic headlamp on/off function is activated, the vehicle will automatically turn on or off the headlamp according to the ambient light. When the ambient light gradually becomes dark, the position lamps and the low beam will be turned on simultaneously; when the ambient light gradually becomes bright, the position lamps and the low beam will be turned off simultaneously.

4. Operation of systems and equipment



CAUTION

- If the message “Sensor failure; please manually control light” appears on the instrument cluster display, the system will keep the low beam on for the sake of safety. In that case, you should manually control the light and go to the GAC Motor authorized shop for inspection in time.
- In the haze environment, it will affect the normal activation of automatic lighting, and the lighting needs to be turned on manually.

Daytime running lamp

- When the engine is started and the low beams are off, the daytime running lamps will be automatically turned on; when the low beam are turned on or the engine is shut down, the daytime running lamps will be automatically turned off.

Position lamp

- Turn the lamp switch to position  to turn on rear position lamps, instrument panel light, license plate lamp, etc., and the corresponding indicator lamp  on the instrument cluster will light up.

NOTE

If you forget to turn off the position lamps when the START/STOP button is turned to “OFF” position and the vehicle is not locked, the position lamps will stay on for about 15 min and then go out automatically in order to save the battery power; when the START/STOP button is turned to “OFF” position and the vehicle is locked, the position lamps will go out immediately.

WARNING

- **When driving the vehicle at night or on a road with poor visibility, please do not only turn on the position lamps. Otherwise, accidents may easily occur.**
- **At night or in poor visibility road environment, when the vehicle stalls and is stopped for a short time, it is necessary to indicate the position of the vehicle by lamps. As the position lamps feature the electricity-saving function, do not use the position lamps as parking lamps. Please turn on the hazard warning lamps for warning.**

4. Operation of systems and equipment

Low beam

- Turn the lamplight switch to the  position to activate the low beam.

High beam

- After turning on the low beam, if you push the lamplight combination switch forward to the limit position, the high beam will be turned on and the corresponding indicator lamp  on the instrument cluster will come on.
- If you pull the lamplight combination switch backward to the original position, the high beam will be turned off.

Headlamp flashing

- If you pull the lamplight combination switch backward to the limit position, the high beam will be turned on.
- If you release the switch, the lamplight combination switch will automatically return to its original position and the high beam will be turned off.

i NOTE

- The high beam may cause dazzling to drivers of oncoming vehicles at close range, which may easily cause accidents. Therefore, please use the high beam reasonably.
- When all the lamps are turned off, if you pull and hold the lamplight combination switch backward, the high beam will stay on, and the corresponding  indicator lamp on the instrument cluster will come on.

Manual headlamp leveling



Rotate the knob ① to manually level the headlamp (low beam) at 0, 1, 2 and 3 positions. The level of the headlamp will decrease as the adjustment value increases.

4. Operation of systems and equipment

Lamp on warning

When the START/STOP button is set to the "OFF" position with the high beam or position lamps on, if you open the driver's door, the system will send a buzzer sound and the instrument cluster display will display the alarm message "Lamp On".



Follow Me Home

Within 10 minutes after switching the ignition to the "OFF" position, if you turn the lamplight control switch from the "OFF" position to other positions and then back to the "OFF" position within 2 s, the headlamp delay off function will be activated. In this case, the low beam will stay on for 30 s, if one of the doors (including four doors, engine hood and liftgate) is opened within this 30 s, this function will be re-timed, and then the low beam will stay on for 80 s, and if all the doors are closed within this 80, this function will be re-timed again, and then the low beam will stay on for 30 s.

Fog lamp switch





When the START/STOP button is in "ON" position with the position lamp turned on, turn the fog lamp switch ② to turn on or off the  (rear fog lamp).

- After the fog lamp switch ② is turned to the position  and then released to the position "OFF", the rear fog lamp will come on.
- Rotate the fog lamp switch ② to  position and release it to "OFF" position, to turn off the rear fog lamp.

Hazard warning lamp



With the START/STOP button in any position, press the switch  to flash the red indicator lamp on the switch and turn on the hazard warning lamp. Press the switch again to turn off the hazard warning lamp.

If the hazard warning lamp is turned on, all turn signal lamps and the indicator lamps  and  on the instrument cluster will flash simultaneously.

4. Operation of systems and equipment



The hazard warning lamp shall be turned on in the following cases so as to attract the attention of persons on the road and reduce the risk of traffic accidents:

- The vehicle is involved in any failure.
- The vehicle is at the tail end of a traffic jam.
- The vehicle tows another vehicle or is towed.
- The vehicle is temporarily parked due to poor visibility.

i NOTE

- The use of the hazard warning lamp will consume the battery power, so please turn it off when not in use.
- Be sure to strictly abide by the relevant regulations when using the hazard warning lamp.
- In the event of an emergency, if the hazard warning lamp is faulty, other methods that comply with the relevant traffic rules and regulations must be taken to attract the attention of persons on the road.

Vehicle assisted lighting

- If you press the unlock button  on the remote control key within the effective range, the position lamps will stay on for auxiliary lighting for a period of time. If you press the  unlock button on the remote control key again, the position lamps can stay on for a longer period of time. When you get in the vehicle and switch the ignition to the "ON" position, the position lamps will go out.

Vehicle locating lighting

- Press the lock button  on the remote control key quickly twice, so the position lamps come on for several seconds and the turn signal lamps flash several times for the purpose of helping you locate your vehicle.

4.3.2 Interior lamp

Automatic light-on function of dome lamps

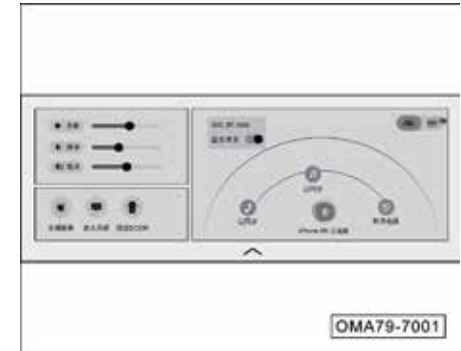

- Swipe down from the top of the screen (dropdown bar area) to call out the dropdown menu interface. Click the "Dome Lamp DOOR" soft key to activate the auto ON function of the dome lamp. Click the soft key again to deactivate the auto ON function of the dome lamp.

4. Operation of systems and equipment

Interior light delay off

When the dome lamps are off and the automatic light-on function of dome lamps is activated:

- With the START/STOP button in "OFF" position, the dome lamps will come on automatically if any door is opened, and go out about 30 s after the doors are closed.
- With the START/STOP button in "OFF" position, if any door is unlocked by remote control, the dome lamps will come on automatically and then go out after about 30 s.
- If the START/STOP button is set from the "ON" position to the "OFF" position, the dome lamps will come on automatically and then go out after about 30 s.

i NOTE

When all the doors are closed and the dome lamps are on as mentioned above, if the vehicle is locked by remote control or the ignition is switched to the "ON" position, the dome lamps will go out automatically.



- When the front dome lamps are off, touch the front dome lamp ① on the corresponding side to turn it on; touch again to turn it off.

2nd-row dome lamp*



- When the 2nd-row dome lamps are off, press the switch ① to turn on the dome lamp on the corresponding side; press the switch ① again to turn it off.

4. Operation of systems and equipment

Smart ambient light*

Access the My Car interface through the 3D model on the main interface of the AV system or the application menu "My Car". Select the "Ambient Light" soft key to enter the interior ambient light effect setting interface.

Operation interface:

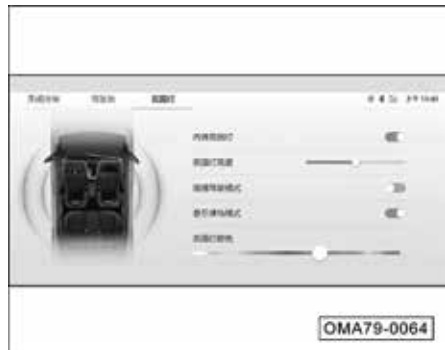

1. Ambient light switch

- Click the soft key  on the right side of "Interior Ambient Light" to turn on or off the interior ambient light.

- When the ambient light function is deactivated, other parameters cannot be adjusted; when the ambient light function is activated with the START/STOP button in "ON" position, the ambient light stays on.

2. Ambient light brightness adjustment

- Users can adjust the brightness of ambient light by clicking or sliding the ambient light brightness progress bar.

3. Drive mode following switch

- When the drive mode following function is activated, the color of the ambient light will change along with the drive mode. That is to say, when the user changes the drive mode, the ambient light color will change accordingly.

4. Music rhythm mode

- If the music rhythm mode is activated, the ambient light will change along with the music rhythm when the music is played.

5. Ambient light color

- Users can select the ambient light color by dragging or clicking on the color bar.

4.3.3 Wiper combination switch

AUTO position

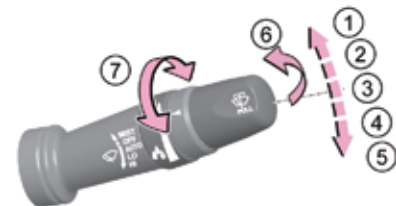

OMA79-0013

INT position

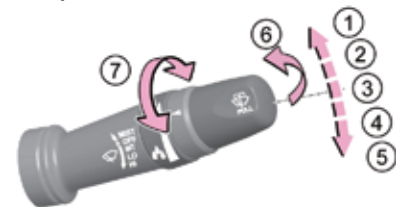

OMA79-0014

4. Operation of systems and equipment

When the vehicle power switch is in the "ON" position, the wiper combination switch can be operated as follows:

- ① MIST: Manual wiping
 - ② OFF: Front windshield wiper off
 - ③ AUTO: Automatic wiping *
 - INT: Intermittent wiping*
 - ④ LO: Low-speed wiping
 - ⑤ HI: High-speed wiping
 - ⑥ Front windshield washer system on
 - ⑦ Adjusting knob:
- Adjust the sensitivity of automatic wiping (AUTO)*
 - Adjust the intermittent wiping (INT)*

MIST: Manual wiping

- Turn the wiper combination switch from the initial position to the limit position ① MIST and release it. Then the wiper combination switch will return to the initial position, and the front wiper will stop moving after wiping once.
- If the wiper combination switch is turned from the initial position to the limit position ① MIST and not released, the front wiper will work continuously.

OFF: Wiper off

- If the wiper combination switch is turned to ② OFF position, the front wiper will stop wiping.

AUTO: Automatic wiping *

- If the wiper combination switch is turned to the ③ AUTO position, the automatic wiping function will be activated, and the wiper system will adjust the wiper speed according to the current rainfall and the real-time vehicle speed.

- This function can be activated or deactivated by setting the AV system "Settings → Body Accessories → Other Accessories → Auto Wiping". When this function is deactivated, the function of the wiper in the AUTO position is equivalent to that in the INT position.
- Adjust the wiping sensitivity by turning the knob ⑦ up/down.

4. Operation of systems and equipment

CAUTION

- When the message “Sensor failure; please control the wiper manually” appears on the instrument cluster, for the sake of safety, you should manually control the wiper and go to the GAC Motor authorized shop for inspection in time.
- Before activating the automatic wiping function in winter, please check whether the wiper blade is frozen.
- It is recommended to deactivate the automatic wiping function when cleaning the vehicle, in dusty weather and in rainless weather to avoid damage or personal injury due to unintentional action of the wipers.
- The automatic wiping function is an assist, so the driver should manually operate the wipers when necessary according to the driving situation to ensure driving safety.
- When stripes, scratches or stains appear at the installation position of the sensor, it may lead to misoperation of the automatic wiper.

INT: Intermittent wiping operation *

- If the wiper combination switch is turned to the INT position ③, the front wiper will start wiping intermittently.
- For the models equipped with the automatic wiping function, this function can be activated by setting the AV system "Settings → Body Accessories → Other Accessories → Auto Wiping".
- Adjust the intermittent wiping speed by turning the knob ⑦ up/down.

LO: Low-speed wiping

- If the wiper combination switch is turned to ④ LO position, the front wiper will wipe at a low speed.

HI: High-speed wiping

- If the wiper combination switch is turned to ⑤ HI position, the front wiper will wipe at a high speed.

Front windshield washer system on

- If the wiper combination switch is turned toward the rear of the vehicle to ⑥ position, the front washer will start spraying water and then the front wiper will start wiping.
- If the wiper combination switch is released to return to its original position, the front windshield washer system will be stopped and the front wiper will wipe once after several seconds.
- After the front wiper stops wiping for several seconds, it will wipe once again so as to clear the residual water stains from the glass.

Front wiper maintenance

- Method 1: Within approximately 10s after the START/STOP button is switched to the "OFF" position, turn the wiper combination switch lever to the manual wipe position ① MIST and then release the switch to allow it quickly returning to its original position. The front wiper stops after reaching its upper limit position and enters the wiper maintenance mode.
- Method 2: With the START/STOP button set to "ON" position, click "Settings → Body Accessories → Other Accessories → Wiper Maintenance Mode" on the AV system display to activate the wiper maintenance mode.

4.3.4 Windshield

Windshield glass



The front windshield is made of green glass.

WARNING

- Always keep the glass surface clean.
- Please affix the necessary identifications according to local traffic laws, rules and regulations. Do not stick paper or hang objects on the surface of the front windshield glass, otherwise the front view will be obstructed, which may easily cause traffic accidents.

4.3.5 Rearview mirror

Interior rearview mirror



Manually adjusting the interior rearview mirror can reduce the light reflected off the mirror surface, thus realizing the optimal rear view.

- As shown in the figure, the tab is at a rearview normal position, which can be pulled forward to offset the light reflected off the mirror surface to achieve the anti-glare function.
- Push the tab backward to return to the normal rearview angle.

4. Operation of systems and equipment

Exterior rearview mirror

i NOTE

If the function of the exterior rearview mirror fails, please go to the GAC Motor authorized shop for inspection in time.

⚠ WARNING

Although the curved (convex and spherical) rearview mirror can expand the field of view, the reflected object image is smaller and farther than the real object. Therefore, when changing the lanes, do not judge the distance between your vehicle and the following vehicle by the reflected image, otherwise accidents may occur due to wrong judgment.

Electric adjustment



- Press “L” or “R” end of the selector button ① to select the left or right exterior rearview mirror.
- Press the adjusting button ② to adjust the selected exterior rearview mirror to the appropriate rearview angle.
- After adjusting the exterior rearview mirror, restore the selector button ① to its original state.

⚠ WARNING

Do not adjust the exterior rearview mirror during driving, so as to avoid danger due to loss of control of the vehicle caused by distraction.

4. Operation of systems and equipment

Electric folding*



- Press the folding button ③ to fold the exterior rearview mirror electrically.
- Press the folding button ③ again to unfold the exterior rearview mirror electrically.

Automatic folding*

- When the vehicle is locked from the outside, the exterior rearview mirror will fold automatically.
- When the vehicle is unlocked from the outside, the exterior rearview mirror will unfold automatically.

NOTE



This function can be activated or deactivated by selecting "System Settings → Body Accessories → Exterior Mirror → Exterior Mirror Auto Folding" on the AV system display.

CAUTION

- If the power folding function fails or the vehicle does not have the power folding function, the mirror can be manually folded. Manual folding requires manual resetting. A click sound can be heard when the mirror is manually unfolded.
- Do not manually fold the rearview mirror with electric folding function frequently; otherwise the internal folding mechanism will be damaged and the electric folding function will fail.
- Be careful during electric folding of the exterior rearview mirror to prevent your fingers from being pinched by the rearview mirror and its base.

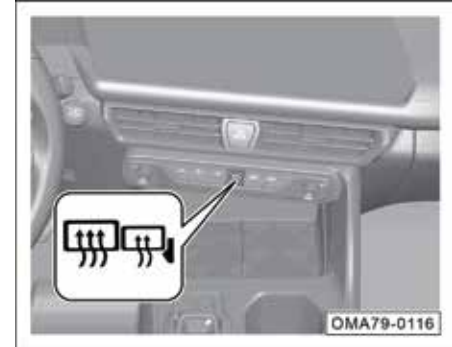
Defrosting and defogging function*



- Press the  button. The button indicator lamp will come on, and the exterior rearview mirror and rear windshield defrost/defog function will be activated.
- This function will be deactivated automatically after about 15 min or manually by pressing down the key , and then the button indicator lamp will go out.

4. Operation of systems and equipment

CAUTION

- If there is still any residual fog or frost to be cleared after the defrosting and defogging function is deactivated automatically, just press the button  again.
- Do not use the defrosting and defogging function for a long time; otherwise the heater may be damaged due to overheating.
- When not needed, the defrosting and defogging function should be deactivated to avoid wasting battery power.

4.3.6 Sun visor



- Turn down the sun visor on the driver's side or front passenger's side in the direction of arrow A to shelter from the incoming sunlight from the front windshield.
- To use the vanity mirror, just turn down the sun visor and pull open the vanity mirror cover in the direction of arrow B to let the vanity mirror lamp* come on automatically.

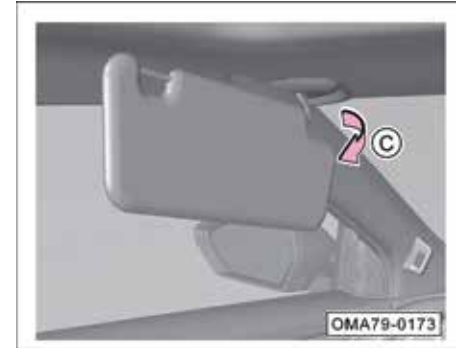

- After turning down the sun visor on the driver's side or front passenger's side, pull it out from the movable bracket in the direction of arrow C to shelter from the incoming sunlight from the side window.

4.4 Seats and storage facilities

4.4.1 Head restraint

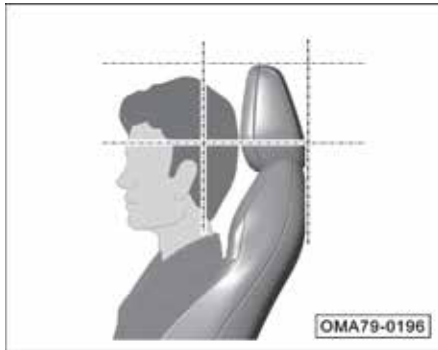

Correct adjustment of the headrests is essential to protect the occupants and reduce the personal injuries in accidents.

Always adjust the head restraint to the correct position (as shown in the figure) according to their body shape.

WARNING

In order to reduce the risk of accidental casualties, please strictly observe the followings:

- Do not adjust the headrest while driving.
- Always keep the headrest in its mounting position. If the headrest is removed or installed improperly during driving, the occupants may be seriously injured in an accident.

Height adjustment of front seat headrests



- Down: Press and hold the lock button , and press down the headrest to the desired position.
- Up: Lift up the headrest directly to the desired position.

NOTE

The adjustment method for the 2nd-row seat headrests is the same.

4. Operation of systems and equipment

4.4.2 Front seats

i NOTE

When measuring the depth of the seat cushion, be sure to adjust the front and rear positions of the seat to the middle of the slide rail and the seat back to the normal operating state (25°).

⚠ WARNING

- Do not place objects under the front seats, for these objects may be caught between the seat and the slider rail, hindering the seat from being locked.
- Do not adjust the seats when the vehicle is in motion, as this can easily cause accidents. The front seats can only be adjusted when the vehicle is stationary.
- Never leave children alone in the vehicle, because the power seat adjustment mechanism still works after the START/STOP button is turned to "OFF" position; if the children accidentally operate the power seat, an accident may occur.

Power seat*

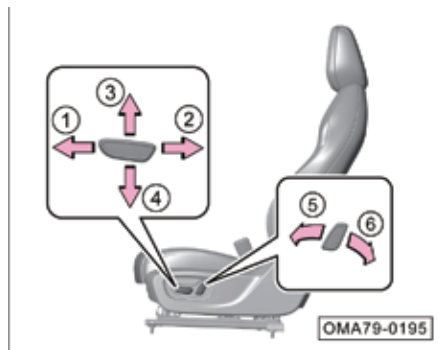

Forward and backward adjustment of seat:

- Push the switch in the direction of arrow ① or ② to slide the seat forward or backward.

Upward and downward adjustment of seat:

- Pull the switch in the direction of arrow ③ or ④ to lift or lower the front end of the seat cushion.

Forward and backward adjustment of seat back:

- Push the switch as indicated by arrow ⑤ or ⑥ to adjust the seat back forward or backward.

Manual seat*



Forward and backward adjustment of seat:

- Pull up the adjustment lever as indicated by arrow ① and slide the seat forward or backward. Then release the adjusting handle, and slide the seat forward or backward slightly until the seat is firmly locked.

Forward and backward adjustment of seat back:

- Pull up the adjusting handle in the direction of arrow ② to adjust the seat back to a desired position, and then release the handle.



Upward and downward adjustment of seat (only for driver's seat):

- Pull the switch in the direction of arrow ③ or ④ to lift or lower the front end of the seat cushion.

4. Operation of systems and equipment

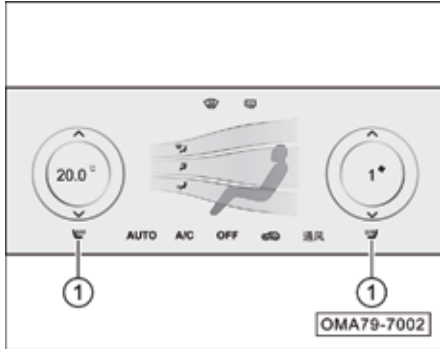
Seat ventilation*/heating*



Set the START/STOP button to the “ON” position, switch the AV system to the A/C control interface, and click the  or  soft key ① to access the seat ventilation/heating setting interface.

Ventilation

- The seat ventilator has three ventilation positions, among which the 3rd position has the highest air volume followed by the 2nd position, and the 1st position has the lowest air volume.

Heating

- The seat heater has three heating positions, among which the 3rd position has the highest temperature followed by

the 2nd position, and the 1st position has the lowest temperature.

Intelligent

- Click “Intelligent” to turn on the intelligent seat ventilation and heating mode.

Deactivation

- Click  to turn off the seat ventilation function.

CAUTION

- Do not kneel on the seat or apply pressure to a point on the seat cushion or seat back, in order to avoid damaging the electrical components in the seat.
- If you feel no temperature change of the seat or feel hot after turning on the heater for a long time, immediately turn off the seat heater and go to the GAC Motor authorized shop for inspection in time.
- If the seat fan is found inoperative after the seat ventilation function is turned on, please turn off the seat ventilation function immediately and go to the GAC Motor authorized shop for inspection in time.

WARNING

If you are sensitive to the temperature change of the seat heater function, please do not use this function to avoid burns by the heater.

4. Operation of systems and equipment

4.4.3 2nd-row seat

2nd-row seat back inclination/recovery



Folding down:

- Press the seat back switch ① and flip the seat back forward to lower the seat back.

Reset:

- Push the rear seat back directly backward until the seat back is locked.

Central armrest*



- Turn down the central armrest forward to use it.

i NOTE

The central armrest shall not be seated by anyone, and shall be stowed to the seat back if the seating position needs to be used.

4.4.4 Storage facilities

Storage compartment on door interior trim panel



- Place beverage bottles, map manuals and other articles here.

4. Operation of systems and equipment

Instrument panel storage compartment



- Place small articles here.

i NOTE

For models equipped with mobile phone wireless charging function, this area is used as the mobile phone wireless charging area, so be sure to deactivate the mobile phone wireless charging function before placing articles in it. => See page 98

Cup holder

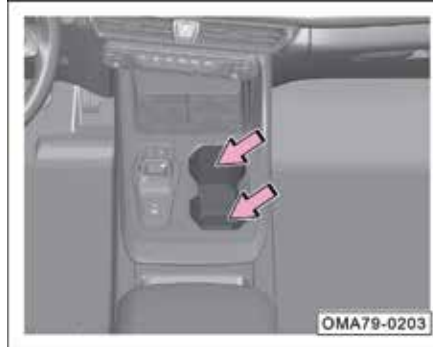

- Front cup holder: For placing beverage bottles.



- 2nd-row cup holder*: Rear cup holder: Turn down the central armrest forward and then place beverage bottles.

⚠ WARNING

Do not place hot beverages on the cup holder, or hot beverages may spill out when the vehicle is running, causing scalding passengers.

4. Operation of systems and equipment

Instrument panel lower storage compartment



- For placing books, ipad, etc.

Front central armrest box



- Open the front seat central armrest box cover upward to place items such as wallets.

Storage bag on the back of front seat



- Pull backward and open the storage bag to place books, foldable umbrellas and other articles.

4. Operation of systems and equipment

Front passenger's glove box



- Pull the handle to open the glove box and place articles such as file bags.
- Push back and close the glove box until you hear a “click” sound.

i NOTE

For vehicles equipped with glove box dampers*, the glove box will automatically and slowly descend when the handle is pulled.

⚠ WARNING

The glove box must be closed when the vehicle is traveling, otherwise the articles in the glove box may fly out and cause injuries to the occupants in case of emergency braking or an accident.

Storage compartment on the back of front center console armrest box*



- Place small articles here.

4.4.5 Low battery reminder

Function description:

The vehicle continuously monitors the battery condition. When the low battery is detected, there will be a risk of power loss in the vehicle. Users will be reminded, through multimedia display or instrument cluster to start the engine to charge the battery, so as to improve the starting performance of the vehicle and extend the service life of the battery.

i NOTE

- The low battery reminder is only intended to remind the low battery, which does not mean that the battery is damaged.
- The low battery reminder function can not prevent the insufficient voltage, so it still requires the user to start the engine and charge the battery in time.
- The use of incompatible batteries or the unauthorized disassembly and modification of vehicle electrical equipment may lead to the false triggering or triggering failure of the low battery reminder function.

4. Operation of systems and equipment

Information to be know:

When the engine is not started, due to the inability of charging, the use of vehicle electrical equipment (such as radio, lights, etc.) will directly consume the battery power, and the battery power will rapidly reduce. If the vehicle electrical equipment needs to be used for a long time, the engine should be started at the same time.

For short-distance driving, due to the short battery charging time, it is recommended that you keep the engine on and continue for a period of time.

If your vehicle is parked for a long time, start the vehicle engine regularly and keep running for a period of time to charge the battery.

4.4.6 Static current management function

Function description:

Continuously monitor the power consumption of electrical equipment and the level of battery power during vehicle parking. When low battery power is detected, gradually turn off unnecessary electrical equipment to reduce the power consumption of vehicle electrical equipment, avoid excessive battery discharge, and extend vehicle parking time. After the vehicle starts, the electrical equipment will immediately resume power supply.

Information to be know:

When the battery power is low during the parking period of the vehicle, some comfort and entertainment functions will be affected. After the vehicle is started, these comfort and entertainment functions will return to normal.

4.4.7 Power outlet/USB port

USB port on the back of central armrest box*



- With the START/STOP button set to "ACC" or "ON" position, a device to be charged can be connected directly for use.

i NOTE

The rear USB port is for charging only.

4. Operation of systems and equipment

Front USB port



- With the START/STOP button in the "ACC" or "ON" position, a mobile device can be connected directly for use.

i NOTE

The USB1 interface ① supports charging, media playback and OTG (mobile interconnection) * functions.

Front TYPE-C port*



- With the START/STOP button in the "ACC" or "ON" position, a mobile device can be connected directly for use.

i NOTE

The TYPE-C port is for charging only.

Front 12V power outlet



- With the START/STOP button in the "ACC" or "ON" position, after the power outlet cover plate is opened, a device to be charged can be connected.

i NOTE

Devices up to 12V/120W are supported.

4. Operation of systems and equipment

4.4.8 Mobile phone wireless charging system *

The mobile phone wireless charging system utilizes electromagnetic induction to realize the charging of the mobile phone without the need for wire connections.

CAUTION

The mobile phone wireless charging system is only suitable for the Qi-certified mobile phones. GAC will not assume liabilities and losses for any accident caused by the use of mobile phones or other wireless charging receivers that have not passed the "Qi" certification.



The wireless charging effective zone is in the storage slot in front of the shift lever. To charge the mobile phone, please align its charging coil with the "Qi" logo to ensure the normal charging.

Mobile phone wireless charging switch

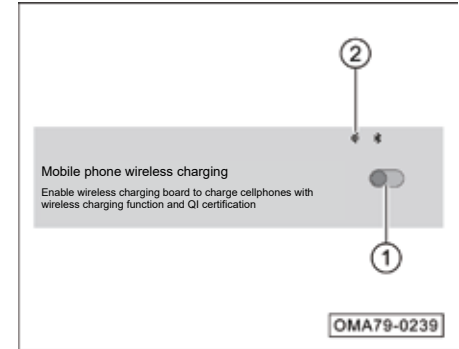

The wireless charging function of the mobile phone is turned on by default, and when the START/STOP button is set to the "ON" position:





- Method 1: -Select "Settings → Body Accessories → Mobile Phone Wireless Charging" on the AV system display, and click the soft key (1) to turn on or off the mobile phone wireless charging system.
- Method 2: Turn on or off the wireless charging system of your phone by clicking the soft key (2) in the AV system status bar.

4. Operation of systems and equipment

i NOTE

After the mobile phone wireless charging system is turned on, the icon ② in the status bar will come on and change as the mobile phone wireless charging system is used. If you click the icon, the corresponding text message will pop up.

Symbol status

Symbol	Color	Status	NOTE
	Gray	Close	The mobile phone wireless charging function is deactivated
	White or black	Standby	The mobile phone wireless charging function is activated, and please use the Qi-certified mobile phone.
	Green	Charging/ Fully charged	-
	Red	Charging failure	Please refer to "Mobile phone wireless charging failure" table

Mobile phone wireless charging failure

Causes	Troubleshooting
The internal temperature of the wireless charging module is too high.	The temperature is too high, so please move away the mobile phone and make another attempt later.
There are metallic foreign objects in the wireless charging module area, or the mobile phone is not centered in the wireless charging module area	There are metallic foreign objects or the mobile phone is placed improperly, so please clear the foreign objects and relocate the mobile phone.
The power supply voltage of the wireless charging module is too low or too high.	The voltage is abnormal, so please move away the mobile phone and make another attempt later.
The mobile phone request charging power is too high, or the wireless charging module transmit power is too high.	The power is abnormal, so please move away the mobile phone and make another attempt later.
The mobile phone status is abnormal.	The charging is interrupted, so please move away the mobile phone and make another attempt later.

4. Operation of systems and equipment

NOTE

- GAC will not assume responsibility for any problem caused by abnormal use (such as the use of external wireless charging coil); if the product is disassembled or modified without any authorization, the free warranty service will be invalidated.
- Only one mobile phone can be charged at a time.
- On bumpy roads, the mobile phone wireless charging function may be intermittently discontinued. If the mobile phone deviates from the charging area and its charging stops, please move the mobile phone back to the charging area.
- The wireless charging function involves both the vehicle and the mobile phone, and if either of them is faulty, it may cause charging failure.
- The charging of the mobile phone may be discontinued when the temperature is too high, and will be continued after the temperature decreases.

CAUTION

- Do not sprinkle water in the storage box to avoid damage to electronic devices caused by water entering the WCM.
- Do not fall small objects such as pebbles, sand, bread crumbs and paper scraps into the charging area to prevent them from entering the internal fan and causing abnormal noise.
- Do not place heavy objects in the charging area to avoid damage to the mobile phone's wireless charging system.
- If the product is faulty and cannot be used normally, please stop using it and go to the GAC Motor authorized shop for inspection in time.
- If there is a metal foreign object between the mobile phone and the charging area during the wireless charging, do not remove the metal object immediately by hand for fear of finger scalding. You should turn off the wireless charging function immediately, then wait until the foreign object cools down before removing it.

WARNING

- **Do not place anything between the mobile phone and the charging pad during the charging. Non-metallic articles may cause the charging performance degradation. Magnetic cards, chip cards or other similar articles may be damaged. Metal foreign objects such as keys and coins may be heated, causing hidden driving safety hazards.**
- **To place metal foreign objects in the wireless charging zone, please first deactivate the wireless charging function through the corresponding menu on the AV system display to prevent the metal objects from sliding into the charging area and being heated during driving, which may cause hidden safety hazards.**
- **When the driver is not in the vehicle, please do not charge the mobile phone in the vehicle, so as to avoid unnecessary safety accidents.**
- **During driving, do not check the charging status of the mobile phone for a long time, for fear of traffic accidents.**

4. Operation of systems and equipment

4.4.9 Trunk

In order to ensure the maneuvering stability of the whole vehicle, the luggage shall be placed as evenly as possible, and the heavy objects shall be placed at the front of the trunk.

WARNING

- **The center of gravity of the vehicle carrying heavy objects may change. If heavy objects in the trunk suddenly slip, the maneuvering stability of the vehicle will change.**
- **Articles in the trunk must be fixed, otherwise they may fly forward and cause injuries to the occupants in case of emergency braking or an accident.**
- **Never place fragile, flammable and explosive articles in the trunk!**

Trunk space

- Fold down the 2nd-row seat back to increase the trunk space. => See page 92

CAUTION

When placing liquids in the trunk, make sure that the container is sealed and the liquid does not leak. Avoid placing liquids on the seat back folded down to prevent liquid leakage and thus wetting the seat.

Objects in trunk

Warning triangle



- There is a warning triangular ① in the trunk. Use of warning triangle. => See page 260

4. Operation of systems and equipment

Trunk carpet



- Open the trunk carpet by lifting the pull rope.

Driver's tools*/ spare tire *

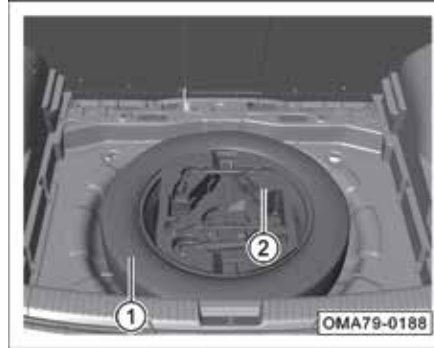

- Open the trunk carpet by lifting the pull rope.
- There are spare tire ①* and driver's tools ② * in the trunk storage box. => See page 259

i NOTE

The driver's tools for some models are fixed on the trunk carpet with Velcro.

4.4.10 Accessories and modification

Data labels and signs indicating important data and information about the use of the vehicle are affixed to the fuel tank cap, engine hood latch and other components of the delivered vehicle. Do not remove or damage these labels and signs, and always keep the data and information on them legible.

The vehicle is designed with the latest safety technologies by GAC to ensure excellent active safety and passive safety. Therefore, in order to maintain the excellent characteristics of this vehicle, please be sure to consult the GAC Motor authorized shop before installing accessories or replacing parts.

It is recommended to use accessories and parts approved by GAC. Other parts than those GAC genuine parts will not be covered by the warranty.

4. Operation of systems and equipment

WARNING

The installation of inappropriate accessories or the modification of the vehicle may affect the maneuvering stability and other performance of the vehicle, and even may cause serious casualties.

To install a car phone, alarm device, transceiver, low-power AV system, etc., ensure that they will not interfere with the electronic control unit such as anti-lock braking system (ABS) on the vehicle.

Before installing the accessories, please ensure that:

1. The accessories neither dim the lamps, nor affect the normal operation or performance of the vehicle.
2. For the vehicle equipped with side curtain airbags*, the accessories must not be installed on the B pillar or across the rear door window. Because the installation in these areas will interfere with the normal function of the side curtain airbags.

NOTE

When additions (such as headrest, seat cover, floor mat, sun protection mat, etc.) are required, inferior additions may contain VOCs that do not meet national standards, and may emit unusual odors, causing hidden dangers that affect the air quality in the vehicle; therefore, the genuine high-quality additions are recommended to ensure a comfortable driving environment.

Modification of vehicle

Dismantling the parts from the vehicle or replacing the genuine parts with non-GAC Motor parts will seriously damage the maneuvering stability and reliability of the vehicle. For example:

- If larger or smaller wheels and tires are installed, they will interfere with the normal operation of the anti-lock braking system (ABS) and other systems.
- If the steering wheel and other safety devices are modified, system failures may occur.

WARNING

Improper modification of the vehicle or installation of inappropriate accessories may easily cause failures and accidents. The accessories and parts approved by GAC are always recommended, because the adaptability, reliability and safety of these accessories and parts have been strictly verified by GAC.

4. Operation of systems and equipment



WARNING

- Improper modification or maintenance of the vehicle may weaken the protective effect of airbags, resulting in system failures and fatal accidents. The accessories such as beverage cup holder and mobile phone holder shall not be installed or connected to the cover of the airbag assembly or within the working range of airbags.
- Improper operation or modification of the vehicle (e.g., modification of the engine, braking system, or components that affect the performance of wheels and tires) will affect the SRS's function, causing serious casualties.
- Do not install wheels and tires that are not approved by GAC.
- The modifications of the front and the engine compartment of the vehicle may weaken the function of the pedestrian detection system and violate road traffic regulations.

4.5 A/C system

4.5.1 General description

The A/C filter can filter pollen and dust entering the air inlet of A/C system.

The A/C filter must be regularly cleaned and replaced according to the Regular Maintenance Schedule in the Warranty Manual.

If the vehicle often runs in areas with poor air quality, the replacement interval of the A/C filter should be shortened. If the airflow from the A/C air outlet is not as smooth as usual, it may be due to the dirty and clogged A/C filter. In this case, clean or replace the A/C filter as soon as possible.

WARNING

If the air in the vehicle is foul, it will make the driver easily fatigued, lack of energy, and distracted, which is easy to cause an accident, resulting in personal injury or even death. Therefore, enable the air circulation mode according to the actual situation.

CAUTION

If the A/C system has failures (such as no cooling, odor in outlet air, etc.), please go to the GAC Motor authorized shop for inspection.

NOTE

- When the START/STOP button is in "ON" position, the A/C system can be operated.
- When the A/C is turned on, there will be water dripped under the vehicle. Prolonged parking with the A/C on will cause accumulated water, which is normal.
- Regularly clean the front windshield wiper cover and remove snow, ice, and leaves to avoid clogging the A/C air intake and ensure normal air intake.
- The A/C system can achieve its maximum effect with the windows closed. However, when the inside temperature is high under hot sun, open the windows briefly to dissipate the inside heat, and then enable the A/C for cooling.

4. Operation of systems and equipment





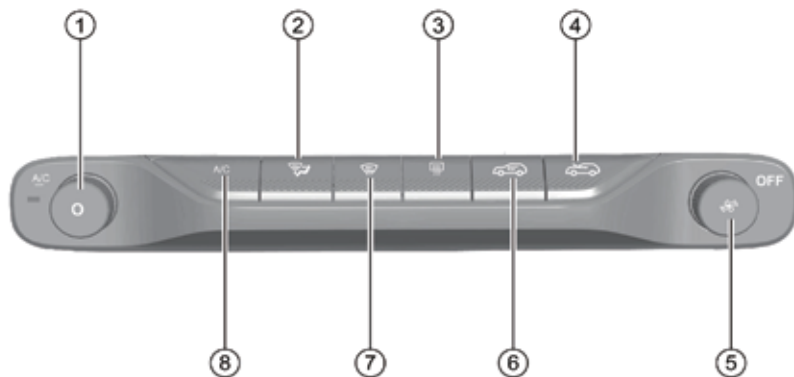



4.5.2 A/C system

Manual A/C system *



OMA79-0046

Manual A/C system *







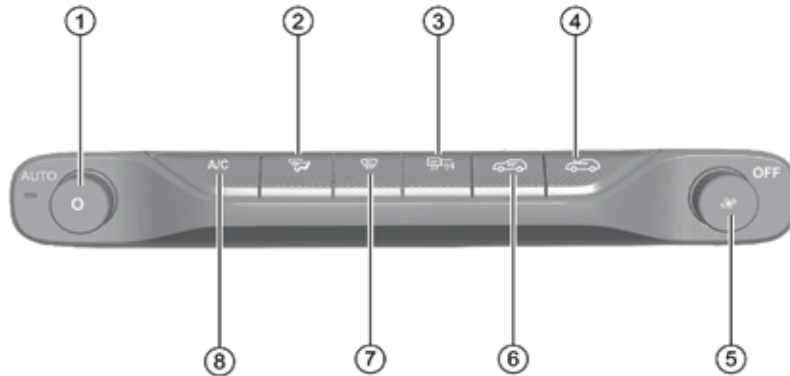

- ①  Maximum cooling mode button/temperature control knob
- ②  Air outlet mode button
- ③  Rear windshield defrost/defog button
- ④  External air circulation button
- ⑤  Fan speed control knob/OFF button
- ⑥  Internal air circulation button
- ⑦  Front windshield defrost/defog button
- ⑧  A/C cooling button

4. Operation of systems and equipment

Auto A/C system*



Auto A/C system*

- ①  Automatic A/C button/temperature control knob
- ②  Air outlet mode button
- ③  * Rear windshield and exterior rearview mirror * defrost/defog button
- ④  External air circulation button
- ⑤  Fan speed control knob/OFF button
- ⑥  Internal air circulation button
- ⑦  Front windshield defrost/defog button
- ⑧  A/C cooling button



OMA79-0045

4. Operation of systems and equipment

NOTE

- Users can also switch to the A/C system control interface by pressing the soft key on the AV system display. The operation of soft keys is roughly the same as that of physical buttons.
- Some functions of the A/C system can be set in the "System Settings → A/C Settings→A/C" interface of the AV system.

Temperature setting

Rotate  /  clockwise or counterclockwise to increase or decrease the temperature at a step of 0.5°C per division.

In auto mode (automatic A/C)*, when LO/HI is displayed, the system will keep high air volume.

In auto mode (automatic A/C)*, in order to obtain the most satisfactory inside temperature, it is recommended to set the temperature to 25.0°C, and adjust the temperature if necessary.

CAUTION

The temperature value displayed on the AV system display is the target value of temperature setting, not the actual measured value of the inside temperature.

A/C cooling button

Pressing the A/C button will start/stop the A/C compressor.

If the A/C cooling (dehumidification) function is activated at an outside temperature below 0°C, the A/C button indicator lamp will come on, but the compressor may not work.



When the A/C button indicator lamp comes on, it indicates that there is a demand for the compressor to start (the compressor may not start).

When the A/C button indicator lamp goes out, it indicates that there is no demand for the compressor to start (the compressor must be turned off).



Auto mode (automatic A/C) *

Press the AUTO button. The button indicator lamp will come on, and the A/C system will activate AUTO mode. The following functions will be automatically controlled according to the set temperature:

- Outlet air temperature.
- Air volume at air outlet.
- Air outlet mode
- Working state of A/C cooling function.

Operate the  knob,  button or  button to exit the AUTO mode of the A/C system.

Maximum cooling mode *









- Press the  button. The button indicator lamp will come on, and the A/C system will activate the maximum cooling mode.
- If the  button is pressed again, the button indicator lamp will go out, and the A/C system will exit the maximum cooling mode and return to the state before the maximum cooling is turned on.

Fan speed setting

If the knob  is turned clockwise or counterclockwise, the fan speed will increase or decrease at increments of 1 level. The AV system display shows the corresponding fan speed level.

In auto mode (automatic A/C)*, in order to make the inside temperature reach the target value, the A/C system will automatically control the fan speed. Operate the knob  to exit the automatic mode of the A/C system.

Turning off of A/C

Press the OFF button to turn off the A/C system. After the A/C system is turned off, the  button,  button,  button, */ button can be effectively operated without turning on the A/C system; To turn on the A/C system, operate the  button*, A/C button,  button*,  button, temperature adjustment knob and air volume adjustment knob.

Air circulation

Recirculation mode

Press the button , and when the button indicator lamp comes on, the air circulation enters the recirculation mode.

When the quality of outside air is poor, use this mode to prevent the outside air from entering the vehicle and recirculate the inside air.

Fresh air mode

Press the button , and when the button indicator lamp comes on, the air circulation will enter the fresh air mode.

When the quality of outside air is good, use this mode to bring the fresh outside air into the vehicle.



CAUTION

- Long-term recirculation mode will cause accumulation of carbon dioxide in the vehicle, which is not conducive to keeping driver clearheaded.
- The recirculation mode in cold or rainy days can easily cause the windows to mist up, affecting the driver's visibility and probably causing serious accidents.

4. Operation of systems and equipment

Front windshield defrost/defog function



Press the  button. The button indicator lamp will come on, and the front windshield defrost/defog function will be activated.



Press the button  again, the button indicator lamp will go out, the front windshield defrost/defog function will be turned off, and the state before defrosting/defogging will be restored; or press the AUTO button  * to enter the auto mode to turn off the front windshield defrost/defog function.

CAUTION

- When the temperature is set to the lowest, the defrost/defog function will cause the outer surface of the windshield to mist up, affecting the driver's visibility and probably causing serious accidents. When using the defrost/defog function, set the temperature close to the ambient temperature outside the vehicle.
- When using the defrost/defog function, if you manually turn off the A/C cooling function, it will cause the front windshield to mist up, affecting the driver's visibility and probably causing serious accidents.
- To use the defrost and defog functions, for quick defrosting and defogging, the default air volume level is higher than 5, and the noise of the air outlet is relatively large. If you want to reduce the noise, you can manually reduce the air volume on the premise of ensuring the driver's sight.

Rear windshield defrost/defog function

Press the */* button. The button indicator lamp will come on, and the rear windshield defrost/defog function as well as the rear windshield and exterior rearview mirror heating function will be activated.

If the button */* is pressed again, the button indicator lamp will go out, and the rear windshield defrost/defog function will be deactivated. If you do not manually turn off the rear windshield defrost/defog function, this function will be automatically deactivated after 15 minutes.





NOTE

With the engine shut down, using the rear windshield defrost/defog function for a long time will cause low battery voltage, making it impossible to start the engine.

4. Operation of systems and equipment

Air supply mode

Press the button  to cycle through the following air supply modes:

-  Panel mode: Air flows out from the panel outlets.
-  panel/floor mode: Air flows out from the panel/floor outlets.
-  Floor mode: Air flows out from the floor outlets.
-  Floor/front windshield defrost/defog mode: Air flows out from the front windshield defrost/defog outlets and floor outlets.

In auto mode (automatic A/C)*, the A/C system will automatically control the air supply mode. When the outlet air temperature is high, most of the air will be directed through the floor outlets; when the outlet air temperature is low, most of the air will be directed through the panel outlets. Press the button  to exit the auto mode of the A/C system.

NOTE

- In order to ensure that the A/C system can effectively control all the air supply modes automatically, please keep all air outlets open.
- Under cold start in winter, the automatic mode will control the air supply mode from the front window blowing mode to gradually transition.

4.5.3 A/C vent

Panel side air outlet



- Toggle the paddle  to adjust the air direction or close the air outlet.

4. Operation of systems and equipment

Panel central air outlet

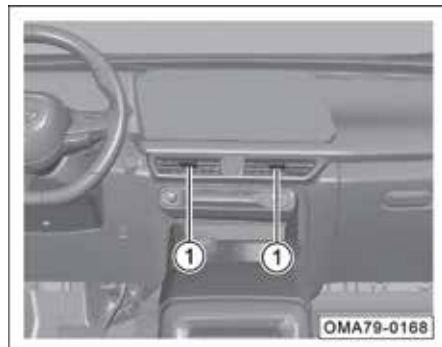

- Toggle the paddle ① to adjust the air direction or close the air outlet.

Rear air outlet*



- Toggle the paddle ① to adjust the air direction or close the air outlet.

4.6 AV system

4.6.1 Control buttons on the right of steering wheel*

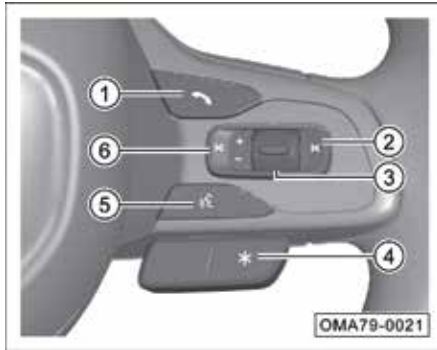

- ① Answer/hang up button of the phone
- When there is an incoming call in the bluetooth call system, you can press the button to answer.
 - When there is an incoming call in the bluetooth call system, you can press and hold the button to hang up.
 - When there is no incoming call in the Bluetooth calling system, you can press this key to enter the Bluetooth dialing interface.
 - When a Bluetooth device is not connected, press this key to enter the Bluetooth settings interface.

- ② Next song/channel switch key
- In radio mode, press this button to automatically search for a valid station with higher frequency. If a valid station is found, the automatic search will be stopped and the station will start playing.
 - In media source playing mode, press this button to skip to the next track.
- ③ Audio source switching button/volume adjustment button/mute key
- Press this button repeatedly to switch as follows: FM → AM → USB → Bluetooth music → FM.
 - Press and hold this button to mute the media source. In mute state, press and hold this button to unmute the media source.
 - Toggle up/down this button to adjust the volume.
- ④ Custom buttons on steering wheel*
- Press and hold or short press down the key to set related functions. For more information, refer to => [See page 114](#)

- ⑤ Voice key
- After connecting the phone to the AV system and activating the CarPlay function, press this key to activate CarPlay voice, and press again to end the voice.
- ⑥ Next song/channel switch key
- In radio mode, press this button to automatically search for a valid station with lower frequency. If a valid station is found, the automatic search will be stopped and the station will start playing.
 - In media source playing mode, press this button to skip to the previous track.

4. Operation of systems and equipment

4.6.2 Custom buttons on steering wheel*



There is a button with the symbol * on the right side of the steering wheel, and its function can be set in the AV system.

The main functions are:

- One-click call
- One-click AVM
- One-click access to main interface
- One-click playback of favorited local radio stations

Custom button setting method

- The functions of custom buttons can be set through the "Settings-Body Accessories-Other Accessories-Steering Wheel Asterisk key" on the AV system display.
- You need to set the phone number of the contact person before using the one-click call function; Ensure that the Bluetooth phone is connected when using.

4. Operation of systems and equipment

4.6.3 Basic operation



① Toolbar

- Return button ◀: Click to return to the previous interface.
- Home button 🏠: Click to return to the main interface.
- System menu button ☰: Click to enter the application menu interface.
- Driving control panel button 🚗: Click to enter the driving control panel.
- Air conditioning information display/control fence area: Display the current A/C information. Click the A/C area to enter the A/C settings interface.

② Smart card area

- Click the cards to quickly enter the corresponding function interfaces.

③ Dropdown menu schematic area

- Drop down to enter the drop-down menu bar control interface.

4. Operation of systems and equipment

- ④ Intelligent scenic area
 - The intelligent scenic area includes 3D model and A/C scenes (quick cooling, quick warming).
 - You can switch between two different scenes: 3D model and desktop wallpaper
- ⑤ System status bar
 - Display "Time", "Bluetooth connection", "Phone wireless charging"* etc. Click the icon to enter the corresponding function interface.
- ⑥ Application menu interface
 - Click the menu  in the toolbar at the bottom of the desktop to enter the application menu interface.

Time setting

- Set the time through "Settings → System Settings → Basic Settings → Time and Date".

Drop-down menu bar

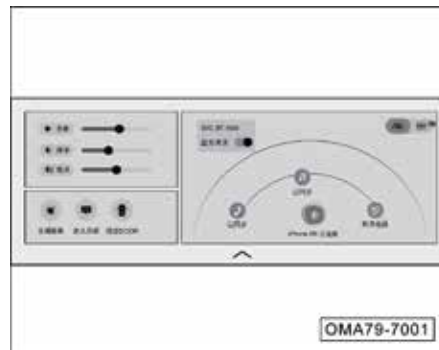

Swipe down from the top of the screen (drop-down menu bar) to show the drop-down menu. Click  or swipe up to hide the drop-down menu bar. In the drop-down menu bar interface, if there is no operation, the drop-down menu will be automatically hid after a period of time.

Click on the function button in the drop-down menu bar to turn on/off the corresponding function.

My Car



After the AV system is turned on and works normally, you can enter the My Car interface by clicking the 3D model in the intelligent scenic area on the main interface or clicking the "My Car" soft key in the application menu interface,.

It is possible to adjust the "opening/closing control (sunshade*, sunroof*, windows, liftgate*)", "cabin (seat ventilation*/heating*, exterior rearview mirror adjustment)", and "lighting effect* (ambient light)".

CarPlay

The CarPlay allows you to use navigation, make calls, send and receive messages, and enjoy music while focusing on driving.

Method 1:

- Use a USB cable to connect the phone and the USB port of the main unit. After successful connection, the system will automatically switch to the CarPlay main interface, and the Apple CarPlay icon in the system interface will be highlighted.
- In other function interfaces, you can access the CarPlay in-car system by clicking on the Apple Carplay icon in the application menu.

Method 2:

- Turn on Bluetooth on the mobile phone, search for the mobile device on the Bluetooth connection interface of the AVNT, click the mobile device, and select CarPlay on the selection box interface after successful connection to connect wirelessly.

Return to the AVNT system operation

- Click the "GAC" icon on the CarPlay application menu interface to return to the AVNT system.
- Click the "CarPlay" icon on the AV system application menu interface to access CarPlay again.

NOTE

- For the functions and applications supported by CarPlay, refer to the Apple's official website. According to the information released by Apple in 2019, Apple CarPlay supports iPhone5 and above.
- When using CarPlay, make sure that the CarPlay function is enabled via "Settings → General → Access Restriction" on the iPhone, otherwise the iPhone will only be used as an iPod and the Apple CarPlay will not be available.
- Please use the genuine iPhone data cable, otherwise connection failure may occur.

4. Operation of systems and equipment

4.6.4 Radio

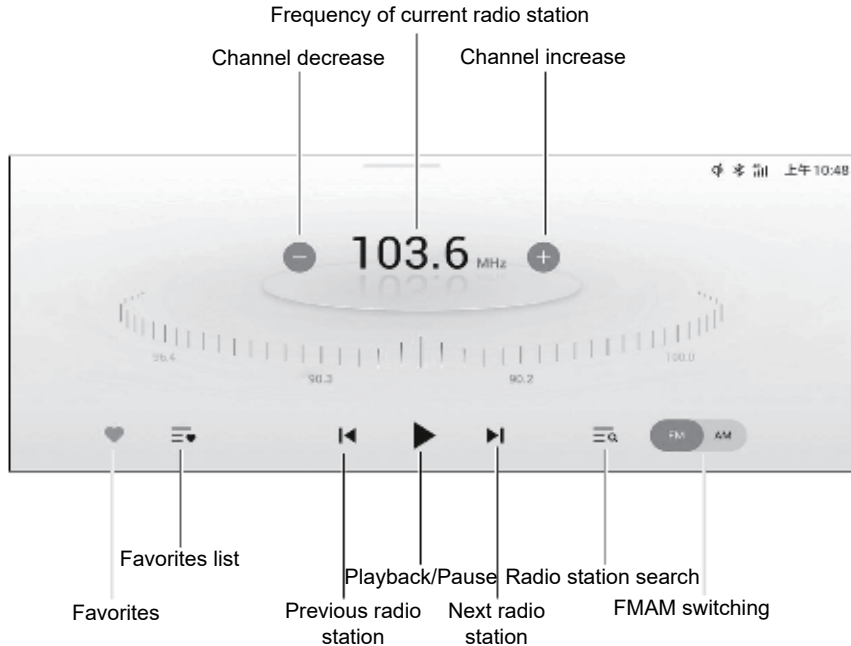

Enter the Radio interface in the following ways:

- Click the “Radio” card in the main interface to enter the radio mode.
- Press the audio source button on the right side of the steering wheel repeatedly to switch to the radio mode.
- Click “Station” soft button through the application menu interface to enter the radio playback interface.

4. Operation of systems and equipment

4.6.5 Music

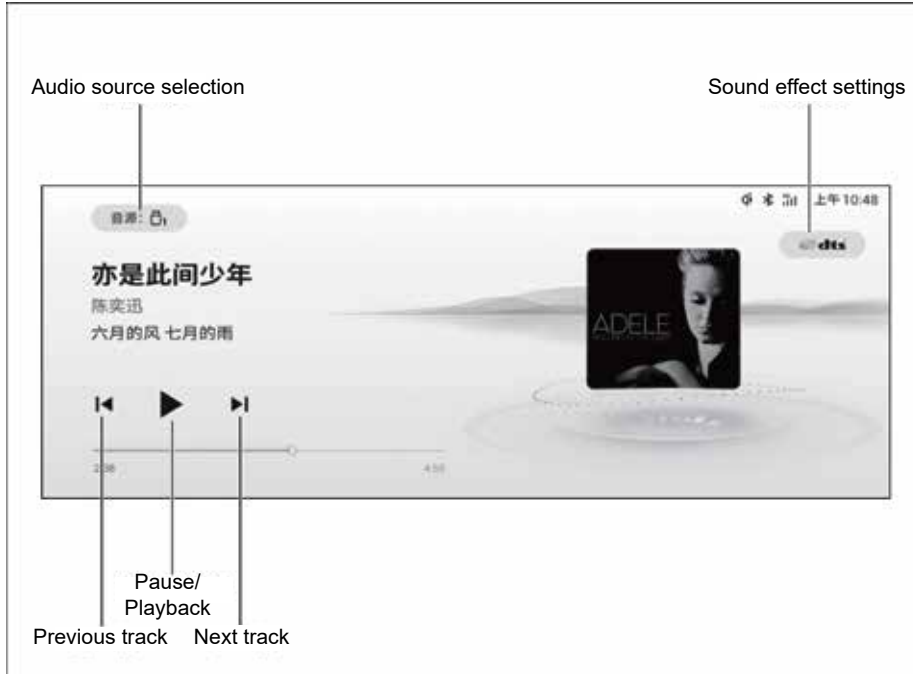

Enter the local music playback interface in the following ways:

- Click the “Music” card in the main interface to enter the music interface.
- Press the audio source button on the right side of the steering wheel repeatedly to switch to the music interface.
- Click the “Music” soft key in the application menu interface to enter the music interface.



i NOTE

The AV system only supports USB devices in FAT16/32, exFAT and NTFS formats, and supports lossless music in APE and FLAC formats.

4. Operation of systems and equipment

4.6.6 Bluetooth function

Enter the Bluetooth mode in the following ways:

- Click the “Bluetooth call” soft key in the application menu interface to enter the Bluetooth mode.
- Press the  button on the right side of the steering wheel to enter the Bluetooth mode.
- Enter Bluetooth mode through the pull-down menu interface
- Click the  soft key in the upper right corner of the status bar to enter Bluetooth mode.

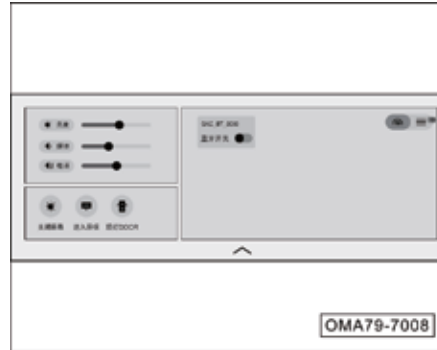

- If no Bluetooth device is connected, enter the Bluetooth setting interface by the above methods described above.
- After turning on the Bluetooth function  by clicking the “Bluetooth ON/OFF” soft key, the AVNT will automatically search for nearby Bluetooth devices. The Bluetooth connection interface displays two display modes: “Radar” and “List”.

Radar display mode



- Bluetooth device: Display the names of nearby Bluetooth devices that can be connected, select the devices to be connected, and click to connect to Bluetooth.
- Switch the list display mode: Click the  soft button to switch to the list mode to display the number of Bluetooth devices that can be connected nearby.

List display mode

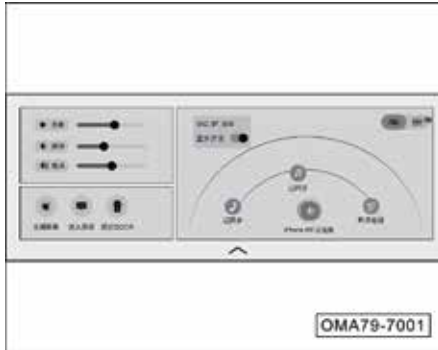
- Bluetooth device: Displays the Bluetooth devices that can be connected to the periphery and displays them in a list style.
- Switch the radar display mode: Click  soft button switch to the list mode to display the number of Bluetooth devices that can be connected to the periphery.



After Bluetooth connection, the status bar icon is highlighted and the name of the connected Bluetooth device is displayed on the Bluetooth connection interface:

- Click the  soft key to synchronize information such as phone numbers and contacts.
- Click the  soft key to synchronize the information of song name played by Bluetooth music player.
- Click the  soft key to disconnect the Bluetooth.

Bluetooth connection failure

Possible cause	Action
The device's Bluetooth function is set incorrectly	Set the device's Bluetooth so that it can be "Visible to Everyone" or can be searched or opened for detection
The current device is not compatible with the in-car Bluetooth system	Confirm the compatibility of the device with the Bluetooth version, update the operating system of the mobile phone to the latest version and try again
The mobile phone's Bluetooth was connected to other devices	It is recommended to delete the Bluetooth devices that were connected

4. Operation of systems and equipment

4.6.7 System settings

Click "System Settings" in the more menu interface to enter the system settings interface. In the settings interface, click on an option to select it, click on the slider  to enable or disable the function, and drag the progress bar for adjustment.

Settings group	Function	Function	Options
Internet	Bluetooth	Bluetooth Name	/
		Bluetooth switch	On/Off
		Auto connection	On/Off
		Auto phone book synchronization	On/Off
		List of Connectable Devices	/
	Device list	Apple Carplay	Add a new device

4. Operation of systems and equipment

Settings group	Function	Function	Options
Sound effect settings	System sound	Multimedia volume	/
		Bluetooth phone volume	/
		DTS sound effect	Off/driver/all passengers
		DTS sound mode ¹⁾	Natural sound/clear voice/super bass/rest
		Equalizer mode ²⁾	Classic/Pop/Jazz/Rock/Default/Custom
		High	-10~10
		Medium	-10~10
		Low	-10~10
		Sound field	Reset
		Speed-sensitive volume control	On/Off
		Startup volume	Unchanged/Adaptive
		Driving assist chime and media sound*	Unchanged/Reduced/Mute
	Unlock/lock tone	On/Off	
	Interactive sound effects	Touch tone	Modern/Retro/Off
Interface sound effects		On/Off	

4. Operation of systems and equipment

Settings group	Function	Function	Options	
ADiGO	Driving tips and memories	Memorize current driving mode	On/Off	
	ADiGO active safety assist*	Forward collision warning	Forward collision warning	On/Off
		FCW distance setting	FCW distance setting	Far/Middle/Near
		AEB	AEB	On/Off
		LDW	LDW	On/Off
		LKA mode	LKA mode	Turning/Warning/Turning and Warning
		Traffic sign recognition (TSR)	Traffic sign recognition (TSR)	On/Off
		Electronic eye speed alarm sound	Electronic eye speed alarm sound	On/Off
		Intelligent speed limit cruise control	Intelligent speed limit cruise control	On/Off
	ADiGO*	Lead vehicle longitudinal distance display	Lead vehicle longitudinal distance display	On/Off
		Intelligent collision avoidance	Intelligent collision avoidance	On/Off

4. Operation of systems and equipment

Settings group	Function	Function	Options
Body accessories	Exterior Light	IHC*	On/Off
		Headlamp delay off*	On/Off
	Door window lock	Remote unlock	All doors//Driver's door only
		Auto unlock	On/Off
		Intelligent active unlocking	On/Off
		Intelligent active locking	On/Off
		Vehicle speed lock	On/Off
		Locking-sensitive window closing*	On/Off
		Electric flush door handle	On/Off
	Exterior rearview mirror*	Auto folding of exterior rearview mirror	On/Off
	Other accessories	Automatic wiper*	On/Off
		Wiper maintenance mode	Setting
		Mobile phone wireless charging*	On/Off
Asterisk key* on steering wheel		One-click call/One-click AVM/One-click access to main interface/One-click playback of favorited local radio stations	
A/C settings	A/C	Setting maximum air volume under the automatic mode*	Low/Medium/High
		Intelligent control of recirculation/fresh air mode	On/Off
		A/C automatic drying	On/Off
		Unlock active ventilation	On/Off

4. Operation of systems and equipment

Settings group	Function	Function	Options
Screen settings	Central control display	Central control screen brightness	/
		A/C interface hold time	5 s/10 s/15 s/30 s
		Desktop wallpaper	Select a new wallpaper
	Instrument display	Instrument panel brightness	/
System settings	Basic settings	Time and date	Setting
		24-hour system	On/Off
	System information	System version	/
		Factory reset	Reset
	Vehicle Information	Manufacturer	/
		Model	/
		Serial number	/
		Current language	/
		Language support	/

Note: 1) It can be selected when the DTS sound effect is set to "All Passengers" or "Driver".

2) It can be selected when the DTS sound effect is set to "Off".

4.6.8 Emergency rescue*

The emergency rescue function includes automatic help-seeking after crash and manual emergency call. Automatic help-seeking is a function that can be automatically activated by GAC Motor T-BOX in certain situations, while manual emergency call requires manually pressing the emergency contact button to activate the function.

The emergency contact can be called through both the automatic help-seeking and manual emergency call functions.

- Automatic help-seeking: If the vehicle has an accidental collision and the airbag detonates, the GAC Motor T-BOX will start the collision automatic rescue function and automatically call the emergency contact person previously set.
- Manual emergency call: When the automatic help-seeking function is not working, you can also manually press the emergency contact button to activate the manual emergency help-seeking function and call the emergency contact number.

Emergency contact button



- SOS button ①: Press and hold (for 3 seconds) to activate the manual emergency call function of GAC Motor T-BOX and call the emergency contact number.

i NOTE

- Please use the emergency call button only when necessary.
- The emergency contact number specified by you is written with your consent during vehicle sales.

5. Driving Guide

5.1 Starting and driving

5.1.1 START/STOP button

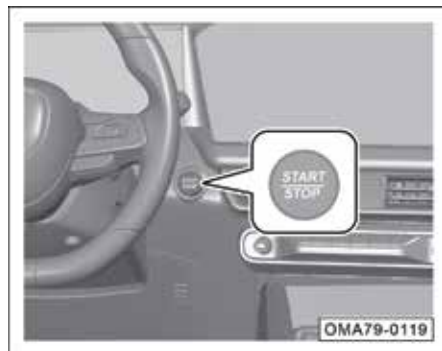

The START/STOP button works only when the intelligent remote control key is detected in the vehicle.

When the transmission gearshift lever is in "P" position and the brake pedal is depressed, the ENGINE START/STOP button backlight will turn green. At this time, press the ENGINE START/STOP button to start the engine.

When the transmission shift lever is set to "P" position and the brake pedal is not depressed, press the START/STOP button to switch the positions in the following order: "OFF → ACC → ON → OFF".

- OFF: The ENGINE START/STOP button backlight turns white, and the ENGINE START/STOP button is switched off.
- ACC: The ENGINE START/STOP button backlight turns orange, and the 12V power supply and other accessories can be used.
- ON: The ENGINE START/STOP button backlight turns orange, the instrument cluster backlight comes on, and all electrical consumers can be used.

Limphome mode



If the battery power of the smart remote control key is low and the instrument cluster display prompts "No key detected", the smart remote control key can be placed horizontally at the key mark at the bottom of the front central armrest box, and then press the START/STOP button to switch to "ACC" or "ON" position, or depress the brake pedal. After the START/STOP button backlight turns green, press the START/STOP button to start the engine.

This method is intended for emergency start. Please replace the battery of the intelligent remote control key as soon as possible.

5.1.2 Engine start

- Enter the vehicle with the intelligent remote control key.
- Set the shift lever to "P" or "N" position.
- Depress the brake pedal and ensure that the START/STOP button backlight turns green.
- Press the START/STOP button to start the engine.

i NOTE

In case of a cold start, run the engine at idle speed to warm up it before driving. At the same time, the valve tappet takes a few seconds to reach the normal working pressure and operation noise will occur, which is normal.

CAUTION

- The engine start time shall not exceed 15s. If the engine is not started successfully, you must wait about 30s before next attempt.
- Do not depress the accelerator pedal hard to make the engine run at high speed or overload after starting. Otherwise, the engine is likely to be damaged.
- If the battery level is low and the engine cannot be started, try to start it by using a jumper cable. => See page 267
- It is prohibited to start the engine by pushing or towing the vehicle.

WARNING

- **Do not keep starting the engine for a long time in a poorly ventilated place or an enclosed place. The engine exhaust contains harmful gases which can make people comatose and even suffocate.**
- **Never let the engine idle when unattended.**
- **Do not add a starting aid for starting the engine, as it is likely to make the engine run at high speed or cause an explosion.**

5. Driving Guide

5.1.3 Engine shutdown

- Park the vehicle steady and apply the parking brake.
- Set the shift lever to "P" position.
- Release the brake pedal, and press the ENGINE START/STOP button to shut down the engine.

i NOTE

After the engine is shut down, the radiator fan may still run for a while.

Emergency shutdown

When the vehicle is running, press and hold the ENGINE START/STOP button or quickly press it three times to switch it from "ON" to "ACC" position for emergency shutdown of the engine.

The engine can only be restarted in a few seconds after emergency shutdown. Restart the engine as follows:

- After setting the shift lever to "P" or "N", press the ENGINE START/STOP button to start the engine.

⚠ WARNING

Emergency shutdown is forbidden during normal driving, as it is likely to lead to vehicle damage, safety and power steering failure, and traffic accidents.

Precautions for parking

When parking, set the gearshift lever to "P" or "N" position, and pay attention to the following:

- Pay attention to the direction when the vehicle is parked, for fear of damage to the green belt due to the exhaust gas spraying on the plants.
- Try to park on a flat and straight road, instead of a steep slope.
- For parking on a slope, regardless of whether the vehicle is facing the top or bottom of the slope, the front wheels should be turned towards the curb.
- Apply the parking brake, shut down the engine, and turn off all lamps and electrical consumers.
- When leaving the vehicle, be sure to take away your valuables and the key, and check that the sunroof*, windows, doors and liftgate are closed.

⚠ WARNING

- **When leaving the vehicle, the engine must be turned off, the parking brake must be applied, and the vehicle key must be carried with you.**
- **Do not leave any person in the vehicle. Otherwise, suffocation, coma and even death can easily occur in the closed space.**
- **Do not park near flammable and explosive materials.**

5.1.4 Instruction for gear



There are "P, R, N, D and S" positions. When the START/STOP button is in the "ON" position, the corresponding gear information should be displayed on the instrument cluster after the gear is engaged.

- Push the shift lever forward to shift from "D/S" position from "R" position. In this process, there are two resistance points. The first resistance point indicates "N" position, and the second resistance point indicates "R" position.

- Push the shift lever backward to shift from "R" to "D". In this process, there are two resistance points. The first resistance point indicates "N" position, and the second resistance point indicates "D" position.

WARNING

The "R" or "P" gear can be engaged only when the vehicle is completely stationary, otherwise the transmission will be damaged.

P: Parking gear



- This position is to be engaged after the vehicle has stopped completely for the purpose of parking.
- When parking for a long time, depress the brake pedal, switch the shift lever to the "N" position, pull up the "EPB" button, release the brake pedal, and then press the "P" button.

5. Driving Guide

NOTE

- Please note that the instrument panel will display the current gear position.
- When the engine is not started, the "D" gear and "R" gear cannot be engaged in by operating the shift lever.
- When the shift system fails and the "P" gear can not be disengaged, please contact the GAC Motor authorized shop for repair.

R: Reverse gear

- This position is to be engaged for reversing.
- When the vehicle is completely stationary and the "P" or "N" or "D" or "S" gear is engaged, depress the brake pedal, and push the shift lever forward to engage the "R" gear.

N: Neutral gear

- This position is to be engaged for temporary parking.
- When the "P" position is engaged, step on the brake pedal and push the shift lever forward to the first resistance position to engage the "N" position.
- When the "D/S" position is engaged, step on the brake pedal and push the shift lever forward to the first resistance position to engage the "N" position.
- When the "R" position is engaged, step on the brake pedal and push the shift lever backward to the first resistance position to engage the "N" position.



WARNING

Do not make the vehicle coast with the gearshift lever in "N" position. Otherwise, it is likely to cause an accident.

D: Forward gear

- Shift into this gear during normal driving.
- Depress the brake pedal, and pull the shift lever backward to shift from "P", "N" or "R" position to "D" position.

S: Forward gear

- When the shift lever is in "D" gear (otherwise "D" gear shall be engaged before the following operations), directly pull the shift lever backward to engage in the "S" gear.
- The shift lever can be repeatedly pulled back to switch gears between "D" and "S".

Driving mode

The driving mode can be switched through the AV system:

- ECO mode: In this mode, the slight power hysteresis occurs and fuel consumption is more economical.
- COMFORT mode: In this mode, the dynamic response and fuel consumption are more balanced.
- SPORT mode: In this mode, the dynamic response is fast and the fuel consumption is high.
- SPORT+ mode*: In this mode, the power is fierce, the roar is loud, and the fuel consumption is high.

Driving mode selection



1. With the START/STOP button set to "ON" position, you can access the driving control panel interface via the soft key  in the AV system toolbar to view the current driving mode or select the corresponding driving mode.



2. With the START/STOP button set to "ON" position, you can switch the driving mode through the "Driving Mode" in AV system application menu.

5. Driving Guide



- Set the current driving mode parameters (in SPORT+ mode*, only the exhaust sound can be set on/off, and other parameters cannot be set) through the "Driving Mode→Current Mode Setting" in AV system application menu.

i NOTE

- The driving mode parameters can be restored to the manufacturer's initial settings with one click (except for SPORT+ mode*).
- To memorize the current driving mode, you need to activate the corresponding function by selecting "Settings→ADiGO Intelligent Driving→Driving Reminders and Memory→Memorize Current Driving Mode" in the AV system. The next time you start the vehicle, the current driving mode will be defaulted to.

5.1.5 Exhaust sound*

The user can switch the exhaust mode through the interactive interface, and control the opening of the tuning valve according to the engine speed, throttle opening and gear signals to realize continuous adjustment of exhaust system acoustics and back pressure. When the exhaust sound valve is opened, the dynamic and pleasant exhaust sound can be heard.



On and Off



Method 1: Turn on or off the exhaust sound according to different driving modes with the exhaust sound button switch ① on the right side of the steering wheel.

Method 2: Select to turn on or off the exhaust sound according to different driving modes through the "Driving Mode→Current Mode Setting→Exhaust Sound" in AV system application menu.

Operation method:

- In SPORT +* driving mode of the whole vehicle, the exhaust sound is turned on and can be turned off by the switch.
- In ECO driving mode of the whole vehicle, the exhaust sound is turned off and cannot be turned on by the switch.
- When the driving modes of the whole vehicle are COMFORT, or SPORT, the exhaust sound is first executed according to the on/off state in the driving mode. The user can change the exhaust sound state by pressing the exhaust sound switch and save the new state to the current driving mode.
- When the exhaust sound is turned on, the instrument cluster will display the exhaust sound icon ; Turn off the exhaust sound and the icon  disappears.

CAUTION

- Turn off the exhaust noise when driving on sections that need to be quiet (such as schools, hospitals, etc.).
- When the vehicle is cold start at a low temperature in winter, the rear exhaust pipe may make a "clang" noise, and the noise disappears after the vehicle is hot. This noise is caused by the action of the rear exhaust pipe sound wave valve to eliminate icing obstruction. When the valve breaks ice or the hot car ice melts, the noise will be eliminated, which is a normal phenomenon. Please feel free to use it. If the exhaust sound function cannot be used normally, go to the GAC Motor authorized shop for maintenance as soon as possible.

5.2 Brake system

5.2.1 Service brake

Under certain driving and weather conditions, squeaks, screams, or other noises may be heard from brakes when the brake pedal is depressed for the first time or lightly stepped on, or braking noise during light or moderate braking, especially for new vehicles (as their brakes have not undergone running-in), which is normal, and does not constitute a failure symptom of braking system nor has effects on the braking safety and performance.

CAUTION

- If there is metal friction rasp, the brake lining may be worn to the limit. Please go to the GAC Motor authorized shop for inspection as soon as possible.
- If the steering wheel vibrates or twitches continuously during braking, go to the GAC Motor authorized shop for inspection as soon as possible.

5. Driving Guide

NOTE

- Do not rest your foot on the brake pedal during driving, otherwise the brakes will be overheated, and the brake linings and brake discs will be worn excessively, increasing the braking distance.
- Continuous application of the brake will cause brake overheat and result in a temporary loss of braking performance.
- Under normal driving conditions, brake linings will wear, and dust will accumulate on wheels, which is inevitable but yet has no effect on the braking performance.
- If rust and corrosion exist because the brake linings and brake discs are not used or used rarely, noise may be heard from brakes for the first use. This is normal. It is recommended to choose a safe area and good road conditions and brake the vehicle several times to clean the brake linings and brake discs.

Brake booster

The brake booster is used to increase the pressure applied by the driver on the brake pedal, and it only works when the engine is running.

If the brake booster does not work properly due to a fault, or when the vehicle is towed, the force on the brake pedal must be increased to compensate for the assist power loss of the brake booster.

WARNING

- **Never make the vehicle coast with the engine shut down, because at this moment, the brake booster does not work, the braking distance will be greatly increased, and an accident is likely to be caused.**
- **If the brake booster does not work (for example, when the vehicle is being towed), please depress the brake pedal with force much greater than that applied under normal condition.**

Braking effect and braking distance

The braking effect and braking distance mainly depend on the driving environment, road conditions and driving style.

With worn brake linings, the vehicle cannot be braked effectively. The wear rate of brake linings mainly depends on the vehicle operation conditions and driving style. If the vehicle is often driven in urban areas, short-distance driving or used as a racing car, it is recommended to increase the frequency of checking the thickness of the brake lining during the maintenance period specified in the Warranty Manual.

After wading, heavy rain or vehicle washing, brake linings may get wet or icy (in winter), resulting in a reduction in braking effects. In this case, the brake pedal must be lightly depressed to heat the brake by friction and evaporate the moisture to restore braking effects.

WARNING

A new tire and brake lining having not undergone running-in do not have the best adhesion and friction characteristics.

- The new tires do not yet have the best adhesion, so please drive carefully within the first 500km to avoid accidents!
- New brake linings in the first 200km to 300km driving distance do not get the best friction characteristics, and braking effects are not as good as expected, so new brake linings must be subject to running-in. Braking effects can be compensated by increasing the force applied to the brake pedal. New brake linings must also be subject to running-in.
- When driving, do not get too close to other vehicles or bring the vehicle to a situation where emergency braking is necessary. Take care especially when driving with a new tire and new brake lining having not undergone running-in, for fear of accidents!

WARNING

When the brake is wet or icy or when the vehicle is running on a salted road, the braking lag may occur, resulting in a longer braking distance. Therefore, be careful to prevent accidents.

- A longer braking distance or a fault in the brake system will increase the accident rate.
- Lightly depress the brake pedal to check the brake.
- Lightly depress the brake pedal to dry the brake or remove ice or anti-skid salt from the brake.

WARNING

When brakes are overheated, braking effects will reduce, increasing the braking distance!

- Take care to avoid overheating the brake.
- When driving downhill, the brake is likely to be overheated as the brake load increases.
- Do not keep depressing the brake pedal. Otherwise, the brake will overheat and the braking distance will increase. Brake the vehicle intermittently according to road and traffic conditions.

5. Driving Guide

WARNING

- The brake fluid must be changed every two years. If the brake fluid stays in the brake system for a long period, air resistance may occur in the pipeline during braking, reducing the braking effect significantly and impairing driving safety, and even causing failure of the brake system, resulting in an accident thereby!
- If the front spoiler is out of standard or damaged, it will block the cooling airflow to the brake, causing the brake to overheat and degrade the braking effect.

5.2.2 Electric park brake (EPB)

The driver can apply or release the parking brake by operating the EPB button. HSA can be applied for driving on a slope. When the accelerator pedal is depressed with the vehicle parked, the EPB will be automatically released to provide driving assistance for the driver.

NOTE

- EPB will choose different application force strategies on different slopes. EPB can realize parking on a slope with a maximum gradient of 30%. If parking on a slope with a gradient greater than 30%, there will be a risk of slipping, and the EPB will be applied again, which is normal.
- If the vehicle continues to slide after the EPB is applied again when the vehicle is parked on a slope with a gradient less than 30% and slips, please depress the brake pedal and drive the vehicle to a flat road. Contact the GAC Motor authorized shop for inspection in time.

Application of static park brake



- When the vehicle is stationary, pull up the EPB button or press the P button as arrowed. The button indicator lamp and the indicator lamp (P) on the instrument cluster will come on, indicating that the EPB has been applied.
- When the shift lever is moved to the “P” position from other positions, the EPB will be applied automatically.

i NOTE

- The EPB can also be applied when the ENGINE START/STOP button is in the "OFF" position.
- After the vehicle is parked steadily, the EPB should be applied first.
- When the EPB is working, operating noise can be heard, which is normal.
- If another vehicle is towed or the subject vehicle is parked on a large slope, the EPB button can be pulled up again after the first application of EPB to ensure the maximum parking force.
- After the first application of EPB for 5min on a slope of 17%~30%, another clamping process will occur, causing noise during operation, which is a normal phenomenon.
- Be sure to apply the EPB during parking.

⚠ WARNING

When the vehicle is running, do not apply the EPB for speed reduction unless necessary, as the EPB only applies braking force to rear wheels, which is likely to cause traffic accidents.

Release static park brake



- With the START/STOP button set to "ON" position and the shift lever not in "P" position, depress the brake pedal, and press the EPB button. The button indicator lamp and the indicator lamp (P) on the instrument cluster will go out, indicating that the EPB has been released.

- With IGN ON, when the doors are closed, the seat belt is fastened, the shift lever is moved to D or R position, and the accelerator pedal is depressed, the EPB will be released automatically, and the EPB indicator lamp (P) on the instrument cluster will go out, indicating the EPB has been released.
- With IGN ON, when the doors are closed, the seat belt is fastened, and the shift lever is moved out of P position, the EPB will be released automatically, and the EPB indicator lamp on the instrument cluster will go out, indicating the EPB has been released.

5. Driving Guide

i NOTE

- If the EPB button is pressed with the brake pedal not depressed, the EPB will not be released, and the instrument cluster will give an alarm message together with an audible beep alarm.
- When the EPB is being released, operation noise will occur, which is normal.
- When the battery is low, the system cannot release the EPB. If conditions permit, you can connect a jumper cable for emergency start, and then release the EPB. Contact the GAC Motor authorized shop for inspection.
- If the EPB has not been used for a long time, the system will perform automatic test, and operation noise will be heard at this time.
- Press and hold the EPB button, and press the ENGINE START/STOP button at the same time to turn off the power supply of the vehicle, which can realize towing in "OFF" position.

Application of dynamic emergency brake



- If the service brake fails during driving, pull up the EPB button constantly, and then release the EPB button or depress the accelerator pedal so that the system exits emergency braking.

i NOTE

- If you pull up the EPB button when the vehicle is running, the instrument cluster display will give an visible warning tell-tale together with an audible beep alarm.
- When the vehicle is slowing down, release the EPB button or depress the accelerator pedal to release the EPB. If you EPB pull up the EPB button continuously until the vehicle stops, the EPB will remain engaged.

👁 CAUTION

Do not use dynamic emergency braking unless necessary, as it is likely to cause traffic accidents. Moreover, the braking distance is longer than braking by depressing the brake pedal, and the service life of the parking brake system will be shortened.

CAUTION

In the following cases, operate the EPB button again. If the fault is not eliminated, please contact the GAC Motor authorized shop for inspection.

- If the indicator lamp (Ⓢ) flashes red continuously, it indicates that the EPB is partially engaged/disengaged or the system is malfunctioning.
- If the indicator lamp (Ⓢ) comes on in red when EPB is not applied, it indicates that the system is abnormal.
- If the indicator lamp (Ⓢ) comes on in yellow, it indicates that a fault is detected in EPB and the EPB is degraded.

AUTO HOLD

On and Off



- When the engine is started, the driver's door is closed and the driver's seat belt is fastened, click the AV system toolbar (Ⓢ) to access the driving control panel interface, where you can click the "AUTOHOLD" soft key to activate the Autohold. At this time, the indicator lamp will come on. Click this button again. The indicator lamp goes out, and the AUTO HOLD is disabled.

Activation

When this function is enabled, it supports automatic brake application and release under stop & go conditions. When the driver brakes the vehicle, the vehicle will be automatically parked to avoid slide at startup.

Exit

Under the following conditions, AUTO HOLD will be disabled and the parking brake will not be locked:

1. The accelerator pedal is depressed at startup.
2. The engine stops while the vehicle is running.
3. The EPB is manually released.
4. The AUTO HOLD button is pressed when the brake pedal is depressed.

5. Driving Guide

For the sake of safety, the AUTO HOLD will be disabled and the parking brake will be locked under one or more of the following conditions:

1. Switch off the vehicle power supply.
2. The driver's door is opened or the seat belt is unfastened when the vehicle is stopped.
3. The AUTO HOLD button is pressed to disable AUTO HOLD.

CAUTION

When driving into a mechanism such as a vehicle washing device that transports the vehicle with a conveyor belt, be sure to disable the AUTO HOLD, otherwise the vehicle cannot move or may run off the path.

5.3 Electronic service brake system

5.3.1 Electronic stability program (ESP)

ESP can effectively reduce the risk of sideslip.

ESP determines the driving intention of the driver according to the steering wheel angle and the vehicle speed, and compares it with the actual driving condition of the vehicle continuously. If the vehicle deviates from the normal driving route (such as sideslip), ESP will correct it by applying brake force to the corresponding wheels.

ESP restores the vehicle to a stable driving state via the torsional force generated by braking.

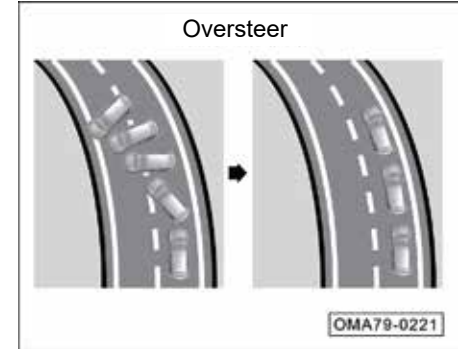

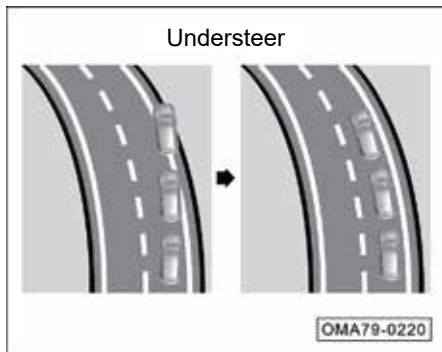

- When the vehicle tends to oversteer (i.e., drift), the system will apply braking force mainly to the front wheel on the outer side of the curve.

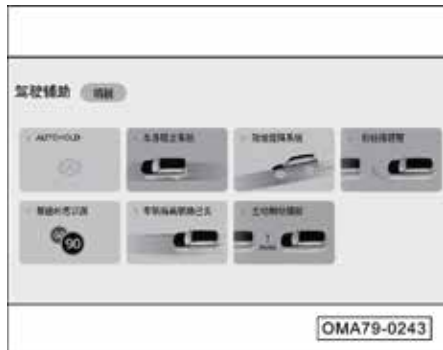

- When the vehicle tends to understeer (i.e., excessive turning radius), the system will apply braking force mainly to the rear wheel on the inner side of the curve.
- A vehicle without ESP deviates from the normal driving route due to sideslip. A vehicle with ESP can correct the braking force according to sideslip, to prevent deviation from the route.

On and Off



ESP is on by default when the vehicle is running. Click the soft key in the AV system toolbar  to enter the driving control panel interface. Click the "ESP" soft key to turn off ESP (only TCS). At this time, the  indicator lamp on the instrument cluster will come on and an alarm message will be displayed.

Since the electronic stability program (ESP) works only when the vehicle is running, the ESP shall be activated for driving safety. The ESP can be disabled in the following special cases:

- When the vehicle travels with tire chains.
- When the vehicle travels on roads covered with deep snow or on soft grounds.
- When the vehicle is trapped on muddy roads, etc., and you need to move it back and forth.

CAUTION

Improper operation or modification of vehicles (such as: Modifications to the brake system, wheels, tires and other components) will affect the function of ESP.

5. Driving Guide



WARNING

- **Be sure to adjust the vehicle speed according to weather, road and traffic conditions at any time. Never risk driving merely by virtue of the additional safety functions provided by the systems.**
- **ESP cannot overcome the physical limit of road adhesion; be careful while driving the vehicle on a wet and slippery road or with a trailer coupled.**
- **The driver should adjust the driving style at any time according to the road and traffic conditions.**
- **ESP cannot reduce the risk of accidents caused by improper driving such as driving at a high speed or driving too close to the vehicle ahead.**

Traction control system (TCS)

TCS refers to traction control system. It determines if the driving wheel slips based on the speed of the driving wheel and the drive wheel, and if the former exceeds the latter, it will limit the speed of the driving wheel. When the vehicle brakes on a smooth road, the wheels will slip, even making the direction out of control. Likewise, when the vehicle starts or accelerates rapidly, the driving wheel may also slip, and the direction may be out of control on a smooth road covered with ice, snow, etc. The TCS is used to automatically control the driving force during vehicle acceleration, so as to keep the slippage of tires within a reasonable range and maintain the driving stability of the vehicle.

5.3.2 Anti-lock braking system (ABS)

Anti-lock brake system (ABS), is an active safety device. When the vehicle is braking, if the front wheels are locked, the vehicle will be unable to make a turn. In this case, steering maneuvers necessary for the driver to avoid obstacles and pedestrians during braking and for driving on curves cannot be achieved. If the rear wheels are locked, the braking stability of the vehicle will be deteriorated, and the vehicle will drift or even turn around under the influence of small lateral force (such as lateral wind force). In addition, when the wheels are locked, local severe friction of tire will significantly shorten the tire life.

For anti-lock brake system (ABS) installed on the vehicle, an electronic control unit is added to the original brake system of the vehicle. Its function is to automatically adjust the wheel braking force and prevent the wheels from being locked during braking, so as to obtain the best braking performance and greatly improve the driving safety.

Advantages of ABS

- Giving full play to the effectiveness of brakes and shortening the stopping time and distance.
- Effectively preventing the vehicle from sideslip and drift during emergency braking, and delivering good driving stability.
- Achieving steering during emergency braking, and delivering good steering control.
- Avoiding severe friction between tires and the ground, and reducing the wear of tires.
- ABS is composed of anti-lock electronic control system and ordinary brake system. The anti-lock electronic control system consists of the sensor, the control unit and the actuator.

Self-diagnosis of ABS

- The ABS ECU has self-diagnosis and fail-safe protection functions. When the ENGINE START/STOP button is set to "ON" position, ABS performs self-test. If ABS does not run normally, the ABS indicator lamp (🚗) will stay on. In this case, stop the ABS, restore normal braking, and go to the GAC Motor authorized shop for inspection as soon as possible.

CAUTION

- Improper operation or modification of vehicles (such as: Modifications to the brake system, wheels, tires and other components will affect the function of ABS.
- Tires must be of a specified size. Incorrect tire size or inconsistent sizes of all tires will affect the normal working of ABS.

WARNING

Be sure to adjust the vehicle speed according to weather, road and traffic conditions at any time. Never risk driving merely by virtue of the additional safety functions provided by the systems.

Electronic brake force distribution (EBD)

As a part of ABS, the electronic brake force distribution (EBD) balances the distribution of braking force on the front and rear wheels according to the vehicle load during normal braking.

Hydraulic brake assist (HBA)

Hydraulic Brake Assist (HBA) is capable of assisting a driver in braking a vehicle under an emergent condition. It determines whether it is necessary to carry out full braking based on the speed at which the driver depresses the brake pedal. As long as the driver depresses the pedal to the floor all the time, the HBA will automatically increase the braking force to the threshold at which the ABS is activated. If the driver releases the brake pedal, the HBA will reduce the braking force to the specified value.

WARNING

HBA is only an assist system for improving the driving safety, but it is subject to the limitation of the laws of kinematics. Therefore, please adjust the driving speed according to the road conditions and traffic regulations.

5. Driving Guide

5.3.3 Hill hold control (HHC)

HHC allows the driver to move the foot from the brake pedal to the accelerator pedal when driving off on a slope without application of the parking brake, so as to prevent accidents resulted from sliding.

System working conditions

1. When the slope degree is greater than 4%, the shift lever is not in the "P" or "N" gear, and no EPB is applied. The driver depresses the brake pedal to stop the vehicle and puts it at a stationary state. At this time, if the driver releases the brake pedal, the HHC function starts to apply braking pressure to the vehicle, and the pressure is maintained for 1 s.
2. During HHC operation, when the engine torque exceeds the drag torque of the vehicle, the brake pressure will be released and the start will be completed smoothly.
3. During driving downhill with transmission in "R" position, the HHC will also work.



- When you drive off on a steep slope or drive downhill with transmission in "R" position, HHC will automatically apply brake to prevent vehicle from sliding.
- HHC is integrated on the ESP system. If the HHC is faulty, the ESP indicator lamp illuminates and displays a graphic prompt through the instrument cluster display.

5.3.4 Hill descent control (HDC)*

The Hill Descent Control (HDC) is a subsystem of ESP. If the driver does not depress the brake pedal while going downhill, HDC helps the driver to decelerate while going downhill via the ESP actively applying braking force.

On and Off



- With the START/STOP button set to the "ON" position, click the soft key in the AV system toolbar  to enter the driving control panel interface. When the vehicle speed is below 35km/h, click the "HDC" soft key to activate the HDC. At this time, the  indicator lamp on the instrument cluster will come on, and the brake lamp will be illuminated when the HDC is working..

- Press the button again to deactivate the HDC and the indicator lamp  on the instrument cluster goes out.

After the HDC function is activated, if the driver does not depress the brake pedal while going downhill, the vehicle keeps running at the speed of at least 8 km/h.

The driver can adjust the vehicle speed by depressing the accelerator pedal or the brake pedal:

- If the vehicle speed is 8~35 km/h when the pedal is released, HDC function is activated again to keep the vehicle going downhill at the current speed.
- When the vehicle speed is higher than 60 km/h, HDC is automatically deactivated.
- When the HDC is active, ESP automatically intervenes in driving if the wheels slip excessively.

NOTE

- When HDC malfunctions, this function will be deactivated, and the instrument cluster will display an alarm message, accompanied by a few seconds of audible alarm. In this case, HDC cannot work properly, and the driver should depress the brake pedal to decelerate on a steep slope, and should go to the GAC Motor authorized shop for inspection as soon as possible.
- In some special environments, the HDC enters the thermal protection mode due to too high braking temperature. For example, when the ambient temperature is high and the system is used for a long time, the temperature of the brake system will keep rising due to friction. Once the limit value is reached, the HDC will enter the thermal protection mode: When the function is activated but does not work, the HDC will temporarily lose its function, and the vehicle may show signs of acceleration. The HDC will not recover until the brake system temperature drops to an effective operating temperature.

5.4 Driver assistance systems

5.4.1 Cruise control system*

The cruise control allows the car to run without depressing the accelerator pedal at the set car speed of 40~120 km/h.

WARNING

- **Do not activate the cruise control system when driving on dense traffic roads, slopes, multi-curve roads or wet and slippery roads, so as to prevent accidents.**
- **The cruise control system shall be used with caution. After setting the vehicle speed, ensure that the vehicle can maintain a safe distance from the vehicle in front.**
- **Turn off the cruise control system in time after exiting the cruise control state.**
- **The cruise control is only used to assist driving and cannot replace automatic driving. Drivers must be alert to driving and control the vehicle.**

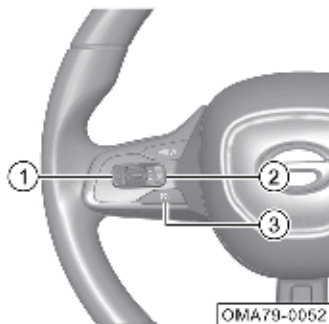

5. Driving Guide

Control buttons



- ① SET /-: Set cruise/deceleration
- ② RES/+: Resume cruise/acceleration
- ③ : Cruise main switch, turn on/off cruise function

Activating cruise control



- Press the main cruise switch button  to turn on the cruise control system, and the indicator lamp  on the instrument cluster will light up in white.
- Increase the vehicle speed above 40 km/h.
- If the SET/- button is pressed, the indicator lamp  on the instrument cluster will turn green, and the vehicle will enter the cruise control status. After that, release the accelerator pedal.

Deactivating cruise control

The cruise control can be deactivated as follows:

- Step on the brake pedal (exit the cruise control and retain the cruising speed value before memory exit).
- Press the main cruise switch button  (to exit the cruise control and delete the cruising speed).
- The gear is switched to "N" gear.
- The engine speed exceeds the allowable range (above 6500rpm or below 800rpm), or the vehicle speed exceeds the allowable range (above 120Km/h or below 35km/h).
- ESP, engine or airbag failure.

Resuming cruise control

When the cruise control is deactivated by depressing the brake pedal or pressing the  button, the indicator lamp  on the instrument cluster will become white, and the cruise control can be reset by pressing the RES/+ button:

- When the vehicle speed is higher than 40 km/h, if the RES/- button is pressed, the indicator lamp  on the instrument cluster will turn green from white, and the vehicle speed will return to the value set during the last cruise control.

Increasing cruising speed

- Press the RES/+ key to increase the vehicle speed by 2 km/h for each press.
- Press and hold the RES/+ button, after which the vehicle speed will continue increasing until the button is released.

NOTE

- The maximum setable cruise speed is 120 km/h. When the vehicle speed is higher than 120 km/h, it cannot be adjusted by the RES/+ button.
- When the accelerator pedal is depressed for acceleration, the vehicle will temporarily deactivate the cruise control and run at the increased speed; after the accelerator pedal is released, the vehicle will resume the cruise control.

Decreasing cruising speed

- Press the SET/-key to reduce the vehicle speed by 2 km/h for each press.
- Press and hold the SET/- button, after which the vehicle speed will continue decreasing until the button is released.

NOTE

When the vehicle speed is lower than 40 km/h, it can no longer be adjusted by the SET/- button.

5.4.2 Adaptive cruise control (ACC)*

The adaptive cruise control system is abbreviated as ACC. It can automatically adjust the following distance to the vehicle in front in cruise control mode.

The ACC detects the relative distance and speed between the front vehicle and the vehicle in the same path according to the MMW radar mounted in the front of the vehicle and the IFC on the front windshield.

- If a vehicle ahead is stopped, ACC controls the vehicle to stop automatically; if the vehicle ahead is started, ACC controls the vehicle to start again automatically within a short time. After stop for some time, the vehicle can be started by operating the  button or accelerator pedal as the vehicle in front is started.
- When the speed of vehicle ahead is lower than the target speed set by the driver, ACC controls your vehicle at a safe distance from the vehicle ahead.
- When there is no vehicle ahead, ACC controls the vehicle to run at a fixed speed at the target speed set by the driver.

NOTE

Precautions for use of radars and IFC sensors. => See page 181

WARNING

- **ACC is not a safety system, obstacle detector, collision warning or anti-collision system, but a comfort system. The driver must always have control of the vehicle and take full responsibility for the vehicle.**
- **The ACC system must be used carefully according to the visibility, weather conditions, road and traffic conditions at the time. The driver must always keep control of the vehicle and take full responsibility for the speed of the vehicle and the distance from other vehicles.**
- **The ACC system cannot replace the driver's attention and decision-making. The driver is always responsible for ensuring that the vehicle runs safely at an appropriate speed and maintains an appropriate distance from other vehicles.**

5. Driving Guide

Control buttons

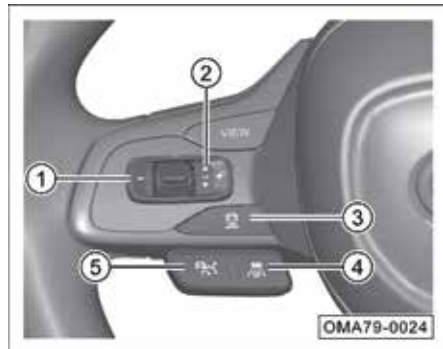

- ① : Deceleration key
- ② : Restore/Synchronize/Accelerate key
- ③ : Adjust the vehicle distance and time interval
- ④ : Start/turn off ICA/switch to ICA
- ⑤ : Start and close ACC/switch to ACC

Interface description

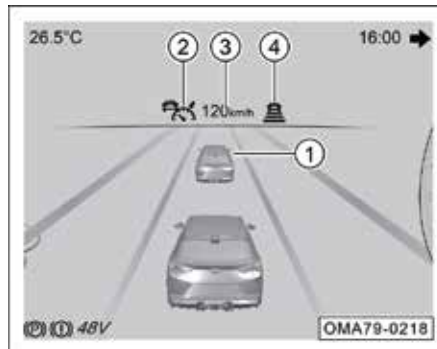

- ① Indicates the detected vehicle ahead.
- ② ACC indicator lamp:
 - The blue ACC indicator lamp illuminates to indicate that the ACC is working with target vehicle ahead. The gray ACC indicator lamp illuminates to indicate that the ACC is in ready state with target vehicle ahead.
 - The blue ACC indicator lamp illuminates to indicate that the ACC is working with no target vehicle ahead. The gray ACC indicator lamp illuminates to indicate that the ACC is in ready state with no target vehicle ahead.

- ! A yellow light indicates a fault in the ACC and should be serviced by the GAC Motor authorized shop in time.

- ③ Indicates the last set cruising speed.
- ④ Set cruising distance from the leading vehicle

When the ACC braking capacity is insufficient to maintain a proper distance between this vehicle and the vehicle in front, the system will send out the "driver takeover request", and the instrument cluster will display the alarm information and sound at the same time. At this time, the driver shall step on the brake pedal according to the system requirements to reduce the speed.

Activating ACC

- Every time the START/STOP button is switched from the "OFF" position to the "ON" position, the ACC will automatically enter the ready state. Press the button, the corresponding blue indicator lamp on the instrument will light up, and the vehicle will enter the ACC control state.

NOTE

- The minimum cruising speed that can be set is 15km/h.
- When the shift lever is not in D position, it cannot enter ACC control.

WARNING

- **When the vehicle is in the "engine running" state, and the shift lever is set to "D" position, press the  button on the steering wheel, and the stationary vehicle will automatically enter the driving state after meeting the conditions. It is necessary to operate with caution.**
- **After the vehicle enters the ACC control state from a stationary state, the speed may suddenly increase. Please ensure safety around the vehicle to avoid unnecessary accidents.**

Deactivating ACC

ACC can be canceled by:

- Opening the driver's door.
- Unfastening the driver's seat belt.
- Depress the brake pedal.
- Set the shift lever to a position other than D.
- Pressing the button  (after that, the corresponding indicator lamp on the instrument cluster will turn gray, ACC will be deactivated, but the set speed will be kept).
- Pressing the EPB button.
- Deactivating the ESP.
- When the HDC system is turned on.
- When Autohold is activated.

Press  to exit the ACC in the following way:

- Depressing the brake pedal.
- Shift lever not in D position (D gear shall be engaged).
- Pressing  button.
- Pressing the EPB button (it is required to release EPB).
- Turn off the ESP system (the ESP shall be turned on again).
- When Autohold is activated (it is required to deactivate the Autohold first).

5. Driving Guide



Resuming ACC

When the corresponding gray indicator lamp on the instrument cluster comes on, ACC can be reset by the following ways:



- Press the  key, the corresponding indicator lamp of the instrument cluster will light up in blue and the vehicle speed will return to memory value of the last cruise set speed and enter the cruise control state.
- If no cruising speed has been set, ACC will set the current vehicle speed as the cruising speed (if the current vehicle speed is lower than 15km/h, the cruising speed will be set to 15km/h).

Increasing cruising speed

To increase the vehicle speed, please operate as follows:



- Depress the accelerator pedal, increase the speed to the target value, and press the button  (keep the accelerator pedal depressed) to cruise at a higher set speed.
- Press the  key, and the vehicle speed will increase by 5 km/h each time it is pressed.
- Press and hold the  key, the cruising speed will continue to increase at 5 km/h until the key is released.

NOTE

- The maximum settable cruising speed is 130km/h.
- When the accelerator pedal is pressed to accelerate, the vehicle will temporarily exit ACC and accelerate with the driver's intention. After releasing the accelerator pedal, the vehicle will return to ACC and set cruising speed.
- When the accelerator pedal is depressed to make the vehicle speed exceed 135km/h, the vehicle will automatically exit ACC. After the vehicle speed is reduced to 130km/h, press the button  or  again to reactivate ACC.

Decreasing cruising speed

To reduce the vehicle speed, please operate as follows:

- Press-key, the vehicle speed is decreased by 5 km/h after each press.
- Press and hold-key, the cruising speed is continuously decreased by 5 km/h until the key is released or the cruising speed is equal to 15km/h.
- During the cruise, lightly step on the brake pedal (ACC exit), keep braking to the target speed, and press the  key to cruise at the current speed.
- During the cruise, press the steering wheel  key (ACC exit), coast or lightly step on the brake to the target speed, and press the  key to cruise at the target speed.





Controlling ACC distance

After the power supply of the vehicle is switched to the "ON" gear, the default distance from the vehicle ahead when the system is turned ON is the fourth gear (the following distance in the fourth range is the farthest).

By pressing the  key, you can switch the gear with the distance from the vehicle in front, and press to switch the first gear once to "Fourth gear → Third gear → Second gear → First gear → Fourth gear....." Sequential cyclically switching of At the same time, the instrument cluster will display the same number of cross bars as the ordinal number of the range.

Activating ACC after following stop

When following a vehicle ahead, your vehicle will also be stopped if the vehicle ahead is stopped. ACC will keep the vehicle stationary through active pressurization via the ESP during a period of time after following stop. ACC will keep the vehicle stationary by starting the EPB after a period of time. When the front vehicle is driving away, the ACC of the vehicle is activated in three situations:

1. If the ACC indicator lamp  is blue, ACC can actively resume and re-drive the vehicle after the front vehicle has driven away.
2. If the ACC indicator lamp  comes on in gray, but the EPB is not started and the Autohold is not activated, the instrument cluster will display "Waiting for Cruise", the driver can restore ACC and re-drive the vehicle by depressing the accelerator pedal or pressing the button .
3. If the ACC indicator lamp  comes on in gray and the EPB is activated, the driver needs to release the EPB first, and then press the button  to restore ACC and re-drive the vehicle.

5. Driving Guide

System limitations

ACC is limited by physical laws and has certain system limitations. In some driving environments, the driver may feel that the ACC response is lagging or fails to control the vehicle as scheduled. Therefore, the driver must be ready to control the vehicle by himself at any time.

The following conditions will affect functions of the radar, so the driver must be particularly alert under these conditions:

1. Decelerating to stop. If the vehicle in front stops with emergency braking, ACC will also slow down or prompt the takeover request. The driver shall actively intervene in braking according to the takeover request alarm to completely stop the vehicle.

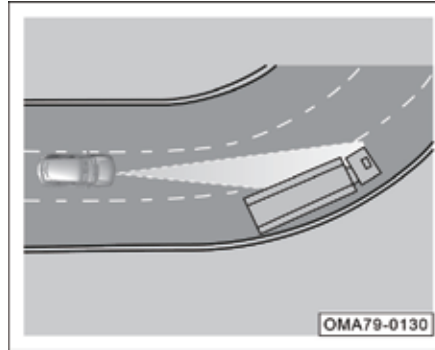

2. Driving through a curve. When driving through a curve, the radar sensor may not catch the vehicle ahead or may not be able to react to the vehicle in the adjacent lane. In this case, the ACC may brake the vehicle, reduce the vehicle speed, or make no response to the lead vehicle. At that time, step on the brake pedal or manually cancel ACC.

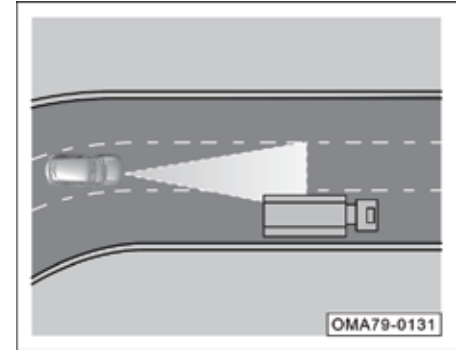

3. Drive out of the curve. During driving out of a long curve, as ACC will calculate the lane in advance, the radar may respond to the vehicles in adjacent lanes and apply the brake of your vehicle. This braking process can be interrupted by depressing the accelerator pedal.

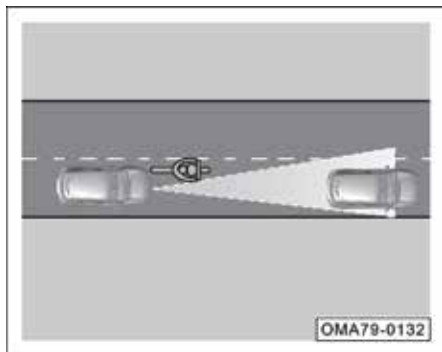

4. Narrow vehicles and Z-shaped traffic in front. The sensor can be identified only when the vehicle in front is narrow or the vehicle in front that is traveling left or right enters the radar sensor detection range, and the system cannot identify the vehicle outside the sensor detection range. ACC may be unable to identify narrow vehicles such as motorcycles, and has a risk of failing to accurately identify the distance from modified vehicles and vehicles involving non-standard transportation in front, so it is not recommended to take such vehicles as the target vehicle ahead.

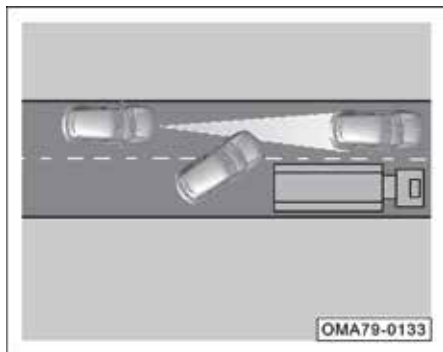

5. When another vehicle changes the lane. When a vehicle in an adjacent lane cuts into your lane but it does not enter the front detection range, the radar sensor may not be able to detect it, resulting in delayed ACC response.

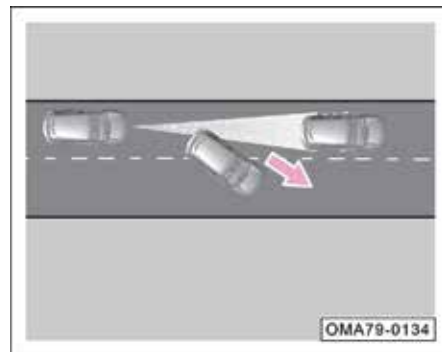

6. If the target vehicle in front is driven out suddenly and a stationary vehicle appears at close range, the radar sensor and brake actuator will incur a response lag, causing delayed braking response.
7. Factors that may deteriorate sensor function:
- Heavy rain, water mist, ice and snow or sludge may deteriorate the radar sensor function, causing the ACC to be temporarily shut down. At the same time, the instrument cluster displays the following text information: 'Cruise system working conditions are not satisfied' or 'The IFC is blocked'. At this time, the ACC and FCM cannot function.

5. Driving Guide

- In low temperature and alpine region, the front windshield is frosted and fogged due to temperature difference or frost, which causes the IFC sensor to be blocked. The instrument cluster will prompt the following text information: 'Cruise system working conditions are not satisfied' or 'The IFC is blocked'. At this time, the ACC and FCM cannot function.
- 8. Brake overheating. If the brake is overheated due to emergency braking or when the vehicle is running down a steep slope, the ACC will automatically turn off temporarily and the following text message will be displayed on the instrument cluster: "Cruise control system working conditions are not satisfied". After that, ACC can no longer be activated until the brake temperature drops to a reasonable degree.

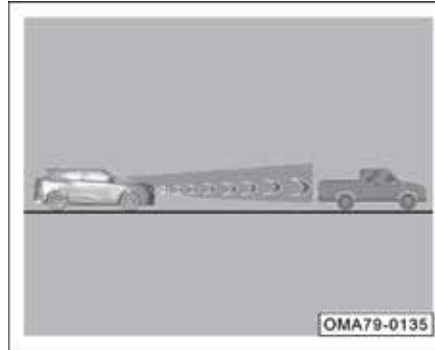

- 9. ACC should not be used in cities with traffic jams and poor visibility (night/backlighting/rain/snow/dense fog, etc.). ACC may not take braking measures in face of people, animals, narrow vehicles such as bicycles, motorcycles or electromobiles, drop frame trailers, approaching or stationary vehicles, and low-speed or stationary trucks/small pickup trucks, so the driver should be particularly alert and always be ready to take over the vehicle.

WARNING

- The ACC function cannot cover all driving scenarios and traffic, weather and road conditions.
- The ACC is only a driver assist system, and cannot replace your attention and judgment. It is your responsibility to maintain a safe distance and speed, and you must be ready to intervene if the ACC fails to maintain a proper speed or distance from the vehicle ahead.
- The takeover prompt alarm of the ACC only warns the vehicles detected by its radar and IFC sensor, so it may not give an alarm, or there may be a certain delay when the alarm is given. Therefore, the driver shall apply the brake as required instead of waiting for the AEB system to operate.

WARNING

- For the sake of safety, ACC is not allowed to be used in urban driving, traffic congestion, many bends and poor road conditions (such as ice, fog, gravel, heavy rain and water skiing), which is in danger of accidents.
- ACC is not a collision avoidance system. If your vehicle is getting closer and closer to the vehicle ahead at a speed higher than that of the vehicle ahead and the braking effect of ACC is unable to stop the vehicle safely before a collision with the vehicle ahead, the driver must depress the brake pedal to reduce the vehicle speed.
- Do not activate ACC during driving in roadless areas or on earth roads. ACC can only be activated on flat roads paved with pitch, cement, etc.

WARNING

ACC will make no or limited response to the followings:

- large speed difference with the vehicle ahead.
- Drive in different lanes, change lanes, or curves with smaller radii.
- Pedestrians, animals, bicycles, tricycles, stationary vehicles or unexpected obstacles.
- Complex traffic conditions.
- Oncoming traffic or cross traffic.
- low trailers or trucks, and vehicles with irregular or non-standard characteristics.

Therefore, be sure to notice traffic conditions and respond accordingly. Do not wait for the system to identify the target or apply the brake, but apply the brake as needed.

NOTE

- Do not bump into the radar sensor. If the sensor is misaligned due to bumps, it will deteriorate the system performance and even cause the system shutdown even through maintenance and correction are made.
- If the surface of the radar or IFC sensor is dirty or covered by heavy rain, ice, snow, sludge, etc., ACC may not function, and the instrument will display the message “The forward radar is blocked” and “The view of IFC is obstructed”. After cleaning the dirt on the sensor surface, the function will return to normal again.
- Do not paint the front bumper or paste decorations such as stickers on the front bumper, otherwise the performance of the front radar sensor may be reduced.
- ACC will not respond to people, animals and vehicles crossing laterally or driving towards the vehicle in the same lane.

5. Driving Guide

i NOTE

- When passing through intersections, speed bumps, steep roads, zebra crossings, or driving on reversible lanes, highway entrances and exits, ramps or construction sections, it is necessary to exit the ACC system and adopt full manual driving, so as to avoid traffic accidents caused by the automatic acceleration of the vehicle to the set speed under these circumstances.
- The ACC system enables the vehicle to drive out automatically after the vehicle is stopped for a short time or after obtaining the driver's confirmation (control button or accelerator pedal). During this period, the driver must ensure that there are no obstacles or other traffic participants directly in front of the vehicle, such as pedestrians/two-wheeler.
- If ACC fails to function properly, stop using it, and go to the GAC Motor authorized shop for inspection in time.

i NOTE

- ACC may not respond under certain circumstances. For example, the system may not respond when a vehicle approaches a stationary obstacle such as a broken down vehicle or a vehicle waiting in a traffic jam, or a vehicle traveling in the same lane approaches the vehicle.
- ACC can only provide limited braking force, and thus cannot be used for emergency braking.
- Do not put your foot on the accelerator pedal unintentionally, otherwise ACC will no longer brake the vehicle. Because the driver steps on the accelerator pedal to refuel may cause excessive speed and distance control.
- When the vehicle is traveling in heavy rain or snow such that ACC is difficult or unable to identify the vehicle ahead, it is required to switch off the ACC.

i NOTE

- When ACC is enabled, the ACC status displayed on instrument cluster may be overwritten by other functions (for example, during telephone calls).
- When ACC brakes the vehicle automatically after activation, there will be a sound different from manual braking sounds or the brake pedal will be depressed automatically, which is normal. This sound and pedal actuation are caused by the operation of the brake system. There is no need to worry.
- For safety reasons, the stored cruising speed will be deleted after the vehicle power supply is turned off.
- You can step on the accelerator pedal at any time to increase the speed. When the accelerator pedal is released, the system will adjust the vehicle speed back to the previously stored vehicle speed.
- If the vehicle enters a tunnel, the radar and IFC may enter the blind mode, and ACC may be turned off temporarily.

Lead vehicle longitudinal distance display

The ACC detects the relative distance between the vehicle ahead and the subject vehicle in the same path according to the radar mounted in the front of the vehicle and the IFC on the front windshield, and the detected relative distance will be displayed on the instrument cluster.

- When there is a vehicle ahead, the relative distance with the vehicle ahead can be displayed on the instrument cluster after selecting "Display Longitudinal Distance from Vehicle Ahead".
- When there is no vehicle ahead, the instrument cluster will not display the relative distance with the vehicle ahead.

Switch on/off

When the START/STOP button is set to "ON" position, the forward collision warning and active brake assist functions are activated automatically.

If manual activation/deactivation is required, the display of the longitudinal distance from the vehicle ahead can be set on/off by selecting "Settings → ADiGO Intelligent Driving → ADiGO Active Safety Assistance → Display of Longitudinal Distance from Vehicle Ahead".

NOTE

Radar sensors and IFC have perceptual limitations and cannot recognize vehicles beyond the detection range of sensor.

WARNING

- **The vertical distance from the vehicle ahead must be used carefully according to the visibility, weather conditions, road and traffic conditions at the time. The driver must always keep control of the vehicle and take full responsibility for the speed of the subject vehicle and its distance from other vehicles.**
- **The driver shall not make judgments and decisions solely based on the display of longitudinal distance from the vehicle ahead. The driver is always responsible for ensuring that the vehicle runs safely at an appropriate speed and maintains an appropriate distance from other vehicles.**

5.4.3 Integrated cruise assist (ICA) system*

Integrated cruise assist is abbreviated as ICA. ICA can automatically adjust the distance from the vehicle ahead during cruise control and keep the vehicle traveling in the middle of the lane at the cruising speed of 0~130km/h.

ACC detects the relative distance and speed with the vehicle ahead in the same path according to the signals from the MMW radar installed on the front of the vehicle and the IFC installed on the front windshield, and detects the lane marking through the IFC.

ICA can improve driving comfort and provide a more relaxing driving experience, such as during long-distance driving in smooth traffic on a highway.

NOTE

Precautions for use of radars and IFC sensors. => See page 181

5. Driving Guide

Operation instruction

Press the button  on the left side of the steering wheel to activate ICA.



After the ICA is activated, follow the operation method of ACC to turn on or activate ICA. The cruise mode can be changed regardless of the status of ACC, including OFF/ON/Active. => [See page 150](#)

The system has a cruise mode memory function. After the vehicle is started, the cruise mode will be the same as the choice when the vehicle was turned off last time.

When ICA system has a specific fault that does not affect ACC, the cruise mode will automatically jump back to the ACC. At this time, the driver cannot choose to enter the TJA/ICA mode, but ACC can still be used normally.

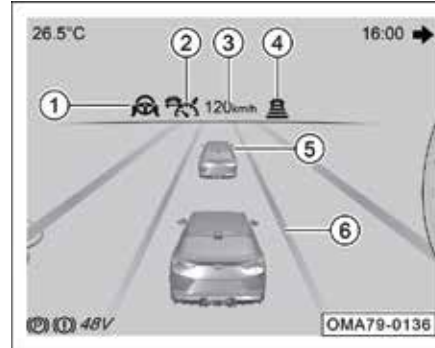
Interface description



- ① Indicates the lateral control status indicator lamp:
- The middle steering wheel is displayed in blue  when the lateral control is activated, and in gray  when in standby.
 - The hands icon on the steering wheel icon is always on when the driver is holding the steering wheel.
 - The hands icon flashes when it is detected that the steering wheel is out of the driver's hands for about 14s with the system activated.
 - The system will also dynamically pop up a text prompt "Please turn the steering wheel slightly" and emit a corresponding prompt tone based on the actual holding state of steering wheel.

- ② ACC indicator lamp
- ③ Indicates the last set cruising speed
- ④ Set cruising distance from the lead vehicle
- ⑤ Detected vehicle ahead
- ⑥ Indicates the lane marking ACC indicator lamp

Lateral control

When ICA is activated, the lateral control function will be automatically activated if an effective lane marking is detected on both sides.

Lateral control will keep the vehicle traveling in the middle between the lane markings on both sides.

The lateral control will be suppressed under the following conditions:

- Lane marking curvature is too high or missing;
- Intense driving conditions
- Turning on the turn signal lamp;
- Turning on the hazard warning lamp;
- The driver turns the steering wheel
- Hands-on reminder given by the system when the driver's both hands are off the steering wheel for a long time;
- ACC exit => [See page 151](#)

The ICA system can only use limited capability of steering system, so it cannot cope with all driving conditions. The driver must keep his hands on the steering wheel all the time and drive with care.

When the ICA system intervenes in turning of the steering wheel for lateral vehicle control, the driver may still turn the steering wheel to control the vehicle. When the torque applied by the system is found improper, the driver can control the vehicle to travel according to his intention when required.

Hands-on reminder



When detecting that the steering wheel is out of the driver's hands for a long time, ICA will issue a hands-on reminder and the instrument cluster will display an icon while beeping.

The driver shall immediately hold the steering wheel immediately after receiving the hands-on reminder. Don't panic or turn the steering wheel fiercely. When the ICA system detects the hand torque applied to the steering wheel, it can recognize that the driver holds the steering wheel with hands, and the takeover prompt is canceled. ICA automatically reactivates the lateral vehicle control.

Note that the lateral vehicle control of the ICA will be inhibited when the steering wheel override prompt is issued but the driver fails to override in a timely manner.

The condition that the driver's hands are lightly holding on the steering wheel may be misinterpreted by the system as the steering wheel out-of-hand. In this case, when the system issues a steering wheel hands-on reminder, the driver only needs to hold the steering wheel tightly or shake the steering wheel slightly, so that the system can detect the torque applied to the steering wheel. Afterwards, the hands-on reminder will disappear.

5. Driving Guide



The braking capacity of service brake system that can be used by ICA is limited, and when ICA requires the driver to intervene in braking, the instrument cluster will display the above picture while beeping.

When receiving the hands-on reminder, the driver shall immediately depress the brake pedal for proper braking.

After depressing the brake pedal, the ICA will exit the activation state. If the emergency situation is eliminated and it is necessary to reactivate the ICA, operate to restore ACC or set the ACC button. => [See page 149](#)

Intelligent collision avoidance

When ICA is activated, the intelligent collision avoidance system will automatically control the vehicle to avoid specific side risks (such as large vehicles in adjacent lanes). The intelligent collision avoidance function can be turned on or off by selecting "Settings → ADiGO Intelligent Driving → ADiGO Active Safety Assistance → Intelligent Collision Avoidance" in the AV system.

The system has a button state memory function, so that when the vehicle is restarted, the system will work in the state before last shutdown.

When the intelligent collision avoidance function is activated, the text prompt reading "Intelligent Collision Avoidance in Progress" will pop out automatically in the alarm pop-up window on the instrument cluster.

Limitations

The capacity of steering system and brake system that can be used by ICA is limited, and ICA cannot maintain an appropriate distance from the vehicle ahead or keep the vehicle in the lane under all road conditions.

ICA may incorrectly detect lane markings or fail to detect lane markings, or may incorrectly detect target vehicles or fail to detect target vehicles ahead. Even if turned on and activated, ICA may be affected, malfunction or not function under the following conditions:

- Poor visibility due to snow, rain, fog, spray, etc.
- Dirty or foggy windshield, or obstructed IFC.
- High ambient temperature around the IFC due to direct sunlight.
- Direct sunlight, oncoming car lights, and reflected light from accumulated water on the road, etc. lead to poor vision.
- Severe changes in illumination conditions, such as in and out of tunnels;

- Headlamp not turned on at night or when the lighting is dim in tunnels.
 - No lane marking, or difficulty in distinguishing the lane marking color from the road surface color.
 - The lane marking is not obvious, such as: too fine, worn, blurred or covered with dirt and snow.
 - The lane is too wide or too narrow.
 - The number of lanes increases or decreases, or the lane markings are complicated.
 - There are more than two lane markings on the left and right sides of the vehicle.
 - Markings or objects resembling lane markings are on the road.
 - Isolation strips or other objects cast shadows on the lane marking.
 - Short-term change of marking, such as ramp or expressway exit.
 - Driving on steep slopes or winding roads.
 - Being too close to the vehicle in front or driving of the vehicle in front blocks the lane marking.
 - Severe shaking of the vehicle.
- The longitudinal control of ICA system is based on ACC. For more limited working conditions, please refer to relevant sections of ACC. => See page 154
- The lateral assist control performance of TJA/ICA may be affected under the following conditions:
- The vehicle is overloaded.
 - The tire pressure is abnormal.
 - The road surface is uneven.
 - The crosswind is strong.
 - The driver modifies the parts related to vehicle control.
 - Replace the vehicle control-related parts with non-original matching parts.
 - Improper assembly of vehicle handling related parts.

i NOTE

When the ICA system controls the steering wheel for assistance, the driver may still turn the steering wheel to operate the vehicle. When the torque applied by the system is found improper, the driver can control the vehicle to travel according to his intention when required.

5. Driving Guide

CAUTION

- If the ICA is disabled for some reasons (e.g., temporary exit due to lane marking, etc.), it will automatically resume when the working conditions are met.
- When the driver judges that the integrated cruise assist does not control the vehicle properly, the driver will grasp the steering wheel for appropriate control, and the ICA function can be interrupted by the driver's operation of the steering wheel.
- The ICA function can be interrupted by the driver's operation, such as stepping on the brake pedal, quickly stepping on the accelerator pedal, pressing the ICA function button, unfastening the seat belt, pressing the hazard warning lamp, etc. The ICA function will be interrupted, and please pay attention to holding the steering wheel with your hands.

WARNING

- **ICA only provides a driving assistance function and cannot address all road, traffic and weather conditions. The driver always takes full responsibility for driving, and shall always check the road conditions and actively control the vehicle.**
- **The driver must hold the steering wheel all the time to actively control the vehicle. When ICA does not provide proper steering assist or relative distance between vehicles, the driver shall intervene timely.**
- **Before using ICA, the driver must read through all sections about this function in the User Manual to understand the system limitations. The driver shall be aware of these limitations before using this function.**

WARNING

- **Improper or negligent use of the ICA system may lead to accidents, so the driver always bears the ultimate responsibility of controlling the vehicle and maintaining an appropriate speed and distance between vehicles, ensuring that the vehicle is running correctly in the lane, even if the ICA system is being used.**
- **The ICA is not a collision avoidance system. When TJA/ICA does not take proper control, the driver must intervene.**
- **Do not use ICA in urban traffic, intersections, watery and snowy roads, bad weather, mountainous roads, undulating roads, highway entrances and exits, etc. Do not use the ICA when the vehicle is connected to the trailer.**

WARNING

- The ICA system may not always recognize lane markings. Missed or wrong recognition of lane markings may result from severe weather conditions, poor lighting, severe changes in illumination such as in and out of tunnels, watery and snowy roads, blurred or non-standard lane markings, shadows projected onto the road surface, braking marks, surrounding vehicles, maintenance facilities, guardrails, and other obstructions, as well as rapid lane changes (such as merging or divergence). Therefore, the ICA system may not generate lateral vehicle control torque when needed, or may mistakenly generate unnecessary lateral vehicle control torque.
- The capability of steering system that can be used by ICA is limited, so it cannot cope with all driving conditions. The driver must keep his hands on the steering wheel all the time and drive with care. The driver must hold the steering wheel or reduce the vehicle speed appropriately on high-speed curves.

WARNING

- The ICA system cannot perform braking for pedestrians, animals, foreign objects, low platform trailers, or oncoming vehicles.
- The ICA does not take effect under all traffic conditions. The lateral vehicle control may suddenly exit in case that the curvature of the lane marking is too high before a sharp bend, there is no lane marking in the road section, etc. Therefore, the driver must always hold the steering wheel and actively control the vehicle.

5.4.4 Forward collision mitigation (FCM) system*

The FCM assesses the danger level of pre-collision by detecting the relative distance and speed with the vehicle ahead in the same path according to the signal from the MMW radar installed on the front of the vehicle and the IFC installed on the front windshield and the driver's other operations (such as depressing the brake pedal or accelerator pedal), gives an alarm to remind the driver to take measures in time in case of a collision risk, and applies the brake automatically when an impending collision is detected. When the driver is braking while the braking force is insufficient to avoid a collision, the system will automatically increase the braking force to avoid or alleviate the collision.

5. Driving Guide

Detectable objects:



- Vehicle
- Two-wheeler
- Pedestrian

i NOTE

Refer to precautions for use of radars and IFC sensors. => See page 181

FCW

FCW issues an alarm for impending collision to alert the driver by detecting objects ahead according to the signal from the MMW radar installed on the front bumper and the IFC installed on the front windshield.

The FCM alerts the driver by the following two methods:

1. Proximity warning

When the early of the FCM is triggered, the FCWS indicator lamp  on the instrument cluster will flash, accompanied by the audible alarm and visual prompt.

2. Brake jerk warning

When the vehicle has a high risk of colliding with the moving target vehicle, brake jerk is triggered to remind the driver that the brake shall be applied immediately.

Active brake assist

When a collision is about to occur, the system will issue an alarm to alert the driver that the vehicle is ready to apply emergency braking according to the signal from the MMW radar installed on the front bumper and the IFC installed on the front windshield, and then will assist in braking and activate the active brake assist function.

Active braking level

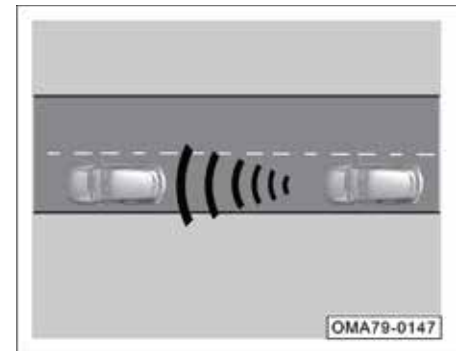

- First-level braking: Brake jerk warning is provided when the ego vehicle is approaching the lead vehicle.

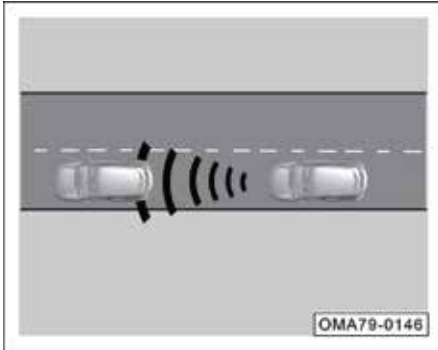

- Second-level braking: Slight automatic emergency braking is applied if the ego vehicle continues to approach the lead vehicle.

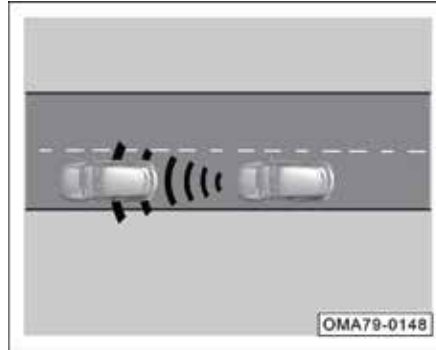

- Third-level braking: Full braking is applied automatically when a rear-end collision is inevitable.

On and Off



- When the START/STOP button is in "ON" position, the FCW and AEB are automatically turned on.
- Activation or deactivation of "FCW" and "AEB" can be set by pressing the soft key  on the right side via "Settings → ADiGO Intelligent Driving → ADiGO Active Safety Assistance → FCW" in the AV system.
- When the FCW and AEB are turned off, a secondary confirmation window will pop up on the multi-function touch screen. At that time, click "Confirm" or "Cancel" to confirm the switch operation.

5. Driving Guide

i NOTE

- The warning distance can be set to "Far, Medium, Near" after FCW is turned on. There is a memory function for the warning distance of the FCW system to remember the last set warning distance.
- After being turned off, FCW and AEB will no longer give an alarm or apply the brake in case of any target vehicle and pedestrian.
- After FCW or AEB is deactivated, they will be activated automatically by default if the START/STOP button is set from "OFF" position to "ON" position again.

System limitations

The FCM is subject to physical and system limitations. For example, the forward collision warning and active brake assist functions may be activated unintentionally or after a certain delay due to intervention by the driver. Therefore, the driver shall stay vigilant and take over control of the vehicle if necessary.

The FCM may work after a certain delay or fail to work when:

- When the ground clearance of the vehicle ahead is very high, such as semi-trailer, etc.
- The rear of the vehicle ahead is low, such as a low-bed trailer.
- The shape of the vehicle ahead is irregular, such as a tractor or a straddle truck.
- The brightness of the surrounding environment changes suddenly, such as tunnel entrance and exit.
- The rear of vehicle ahead is small, such as an unladen truck.
- A detectable object ahead performs emergency acceleration, deceleration and steering.
- A detectable object ahead is suddenly driven in front of the vehicle.
- There is a bicycle with a special shape ahead, such as a tandem bicycle.
- The vehicle is driven at a very high speed.
- The vehicle is driven on a slope.
- The vehicle is running on a narrow curve.
- The accelerator pedal is depressed hard or the vehicle accelerates quickly.
- The assist function is deactivated or operates abnormally.
- The ESP function is manually disabled.
- The vehicle enters ESP control.
- The surface of the area where the IFC is located or the radar sensor surface is dirty or covered by foreign matters.
- Reverse the vehicle.
- In chaotic traffic conditions.
- The vehicle is towing another vehicle.
- Pedestrians stand on traffic safety islands or bends.
- Pedestrians are completely or partially covered by other objects, such as workers holding ladders, pedestrians holding umbrellas, etc.

- Pedestrians wearing fancy clothes or masks, for example, carnival costumes.
- Poor visibility, such as sunset, night, snow, heavy rain, fog, backlight, etc.

If a collision is impossible, the system may work when

- There are patterns of detectable objects in front of the vehicle.
- This vehicle is overtaking the vehicle that changes lanes or turns right or left.
- This vehicle is overtaking the vehicle that is ready to turn right or left.
- There is a detectable object at the bend entrance.
- The vehicle changes lanes in the process of overtaking the detectable object.
- The vehicle is approaching the front detectable target in the winding lane or when changing the driving route.
- The vehicle runs under portal frames, billboards, road signs, etc.
- There are manhole covers, steel plates and other metal objects in front of the vehicle.

- The vehicle approaches a roadside telegraph pole, railing, tree, etc.
- When driving through grass, branches, banners and other objects that may come into contact with the vehicle.
- When driving near an object that reflects radio waves.

WARNING

The active brake assist function must be deactivated when

- **The vehicle is towed.**
- **The vehicle is on a chassis dynamometer.**
- **A radar sensor or IFC sensor has a fault.**
- **The radar sensors are under external force (such as in case of rear-end collisions).**

WARNING

- **FCM can improve the driving safety, but it is still subject to the limitations of laws of physics, and thus shall never be used for risky driving. The driver must always be ready to apply the brake to reduce the vehicle speed or avoid obstacles.**
- **The FCM only provides warning and collision mitigation for vehicles/pedestrians detected by the radar and IFC, so there may be no response or a certain delay in the response. Therefore, the driver shall apply the brake if necessary instead of waiting for the FCM to operate.**
- **The FCM only provides the driver with a warning to avoid collision and limited braking to reduce the collision injury. It is impossible to prevent the vehicle from accidents or personal injuries autonomously. The driver must always control the vehicle and take full responsibility for the speed of the vehicle and the distance from other vehicles.**

5. Driving Guide

WARNING

- When the FCM is turned on, the driver must always keep control of the vehicle during driving, and take full responsibility for the speed of the vehicle and the distance from other vehicles.
- Never ignore any suddenly activated warning lamp and reminder displayed on the instrument cluster, otherwise a traffic accident and even serious injuries may occur.
- Therefore, the driver shall always observe traffic conditions instead of completely relying on the active brake assist function. As it is only a driver assistance function, the driver shall be fully responsible for keeping a proper distance from the vehicle ahead, controlling the speed and braking in time. The driver must always be ready for braking or steering.

NOTE

- The FCW alerts and the active brake assist function's intervention in braking can be stopped by depressing the accelerator pedal or turning the steering wheel.
- In a complex driving environment (such as traveling on a circuitous road), the FCW and active brake assist functions may give an unnecessary warning and brake the vehicle unnecessarily.
- When the active brake assist function is activated, the vehicle will be braked, and the foot may feel hard or vibration from the brake pedal, which is normal.
- When affected by factors such as aelectromagnetic field interference, the target's own reasons or the environment, detection will be interfered and the performance will be degraded.
- When the instrument displays "Please check front collision mitigation system", it indicates that the front collision mitigation system has been deactivated. Please contact a GAC authorized service station in time.

5.4.5 Traffic sign recognition (TSR)*

Traffic sign recognition is abbreviated to TSR. TSR provides the driver with speed limit information by detecting speed limit signs ahead on the road through the IFC installed on the front windshield and according to data from the navigation of the AV system, and alerts the driver to overspeed when the speed limit is exceeded.

On and Off

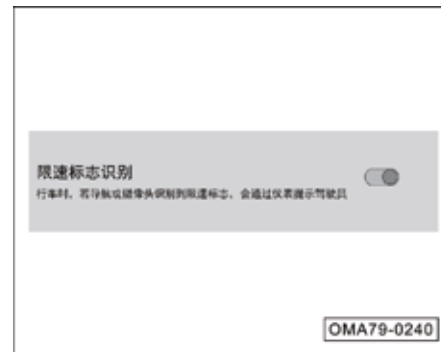

Activation or deactivation of TSR can be set by selecting "Settings → ADiGO Intelligent Driving → ADiGO Active Safety Assistance → TSR" in the AV system.

After this function is turned on, if the navigation system or IFC recognizes the speed limit sign on the road ahead, the speed limit value will be displayed on the instrument cluster; if the current vehicle speed displayed on the instrument cluster exceeds a certain threshold over the speed limit, the speed limit sign icon on the instrument cluster will keep flashing.

i NOTE

The system has a button state memory function, so that when the vehicle is restarted, the system will work in the state before last shutdown.

Description of display interface

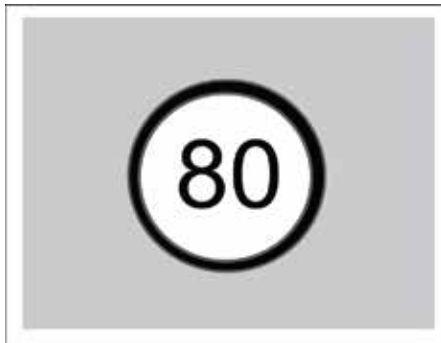

A normal speed limit is identified, including but not limited to general speed limit sign, combined speed limit sign, divided lane speed limit sign, electronic eye speed limit, and interval speed limit.

When the actual speed of the vehicle is slightly higher than the speed limit indicated by the instrument, the speed limit symbol on the instrument cluster will keep flashing.

Deactivating/activating speed alarm sound

Activation or deactivation of traffic alarm overspeed warning tone can be set by selecting "Settings → ADiGO Intelligent Driving → ADiGO Active Safety Assistance → Traffic Alarm Overspeed Warning Tone" in the AV system.

After this function is activated, when the actual speed of the vehicle is slightly higher than the speed limit indicated by the instrument and there is an electronic eye for speed measurement on the current road, except that the speed limit sign on the instrument cluster will flash for a period of time, a speed alarm sound will also be given to remind the driver.

The system has a button state memory function, so that when the vehicle is restarted, the system will work in the state before last shutdown.

5. Driving Guide

Function limitations

The TSR, even activated, may involve wrong or failed detection of speed limit sign due to inevitable environmental factors and conditions. The system may become affected or inoperative under the following conditions:

- The IFC is blocked or disturbed by strong light.
- At night or when the light is weak in the tunnel, the headlamp is not turned on or the headlamp cannot fully illuminate the speed limit sign.
- The speed limit sign is partially or completely blocked.
- The speed limit signs are worn, blurred or smudged.
- The speed limit sign is not properly placed, such as involving twisting or tilting.
- The speed limit sign is blocked by vehicles and obstacles in the next lane.
- The speed limit has been changed due to temporary road construction.
- Navigation data is not updated online in time or inaccurate.
- The road is not standardized. Other road signs are mistakenly identified as speed limit sign.

- Inaccurate navigation and positioning results in the output of non-local road speed limit information.

WARNING

- **The TSR can only recognize speed-related signs instead of other signs on the road.**
- **The TSR can only identify the maximum speed limit of the road. Do not rely on TSR to determine the appropriate driving speed. Always drive within the safe speed range according to the speed limit and road conditions.**
- **The TSR can only work under some conditions. The driver shall always assume the ultimate responsibility for safe driving and comply with applicable laws and road traffic rules.**

5.4.6 Intelligent speed limit adaptive cruise control (ISL-ACC)*

Intelligent speed limit adaptive cruise control is abbreviated as ISL-ACC. When there is a speed limit sign in the front path, ISL-ACC sends a cruise control target speed synchronization prompt through the speed limit sign recognition (TSR) information, and the driver selects whether to synchronize the cruise control target speed.

On and Off

Activation or deactivation of intelligent speed limit control can be set by selecting "Settings → ADiGO Intelligent Driving → ADiGO Active Safety Assistance → Intelligent Speed Limit Control" in the AV system.

When the TSR is turned off, this function is synchronously turned off; After the vehicle is restarted or the TSR is turned on again, the intelligent speed limit control switch will return to the previous state.

i NOTE

The system has a button state memory function, so that when the vehicle is restarted, the system will work in the state before last shutdown.

Triggering requirements of the ISL-ACC speed limit prompt

To trigger the ISL-ACC speed limit prompt, the following requirements must be met:

- ISL-ACC is turned on.
- ACC is in working state.
- ACC's current target vehicle speed and TSR speed limit are greater than the system's set difference.
- The TSR identifies the speed limit sign for the first time or the vehicle speed changes after the speed limit sign is identified.

After the ISL-ACC speed limit alert is triggered, the driver will be alerted about whether to synchronize with the current TSR within the next 5s.

Target speed of ISL-ACC

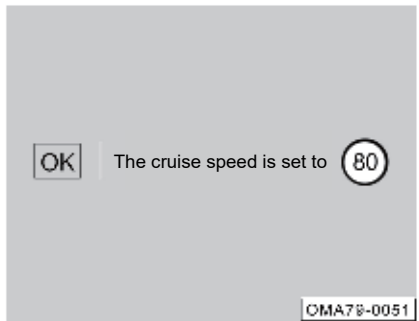

When the pop-up text prompts "Cruising speed set to", "Current speed limit sign" and "OK" appear on the instrument panel:

1. When the driver presses the OK button, the driver agrees on the synchronization of the speed limit sign, and the ACC target vehicle speed is set to the speed value of the current speed limit sign.
2. When the driver does not operate the OK button 5s after the prompt message appears, it means that the driver does not accept the synchronization with speed limit, and the target speed of the ACC will remain unchanged.

⚠ WARNING

- The intelligent speed limit control is a driving assistance function, which sends the speed limit prompt depending on the TSR. Do not rely solely on the intelligent speed limit control to determine the appropriate driving speed. Always drive within the safe speed range according to traffic and road conditions.
- ISLACC cannot work under all conditions. The driver shall always bear the ultimate responsibility for safe driving of the vehicle and comply with applicable laws and road traffic rules.

5. Driving Guide

5.4.7 Lane departure warning (LDW) system*

The lane departure warning system is designed to reduce accidents caused by unintentional lane departure.

The LDW detects the lane markings on the road through the IFC installed on the front windshield, analyzes the action of the driver and moving status of the vehicle, and gives a warning or intervenes in turning of the steering wheel for corrective steering adjustment when the vehicle unintentionally drifts out of lane due to fatigue, distraction or phone calls of the driver. It usually gives a warning or interferes with the steering wheel when the front wheel crosses a lane marking.

When the driver selects "Steering" or "Steering and Warning" as the LKA mode and the operating conditions of the lane departure warning system have met, the system monitors the torque applied to the steering wheel. When the driver keeps his hands off the steering wheel for a long time, the system will alert the driver.

On and Off

Activation or deactivation of LDW can be set by clicking the soft key  on the right side of "LDW" via "Settings → ADiGO Intelligent Driving → ADiGO Active Safety Assistance → LDW" in the AV system.

When the function is turned on, the button will be in on state, and the LDW indicator lamp  on the instrument cluster will come on; when the function is turned off, the button will be in off state, and the LDW indicator lamp on the instrument cluster will go out.

The system has a button state memory function, so that when the vehicle is restarted, the system will work in the state before last shutdown.

Select the LKA mode

When the START/STOP button is set to "ON" position, select the LDW mode via "Settings→ADiGO Intelligent Driving → ADiGO Active Safety Assistance→LDW Mode" in the AV system.

1. Steering
 - When "steering" is selected, the system only intervenes in the steering wheel for corrective steering adjustment.
2. Warning
 - The system only issues a warning when the "Warning" is selected.
3. Steering and warning
 - When the "Steering and Warning" is selected, the system will both warn and intervene in the steering wheel for corrective steering adjustment.

NOTE

The LDW has the lane keeping assist mode memory function, so the lane keeping assist mode before last shutdown will be selected when the vehicle is restarted.

How it alerts the driver

The lane departure warning is only activated when "Warning" or "Steering and warning" has been selected as the LKA mode.

- When the vehicle speed is greater than 65km/h and the system detects at least a valid lane marking on one side, the status indicator lamp  on the instrument cluster will come on in blue. It indicates that the system may issue a lane departure warning in this case. When only one side of the lane is recognized, the system only alarms for that side.

When the indicator lamp  is blue, the system will not give an alarm if the vehicle deviates from the lane under one of the following conditions.

- Step on the brake pedal for deceleration with great braking force.
- Turn on the turn signal lamp on the corresponding side.
- Turn on the hazard warning lamp.
- Turn the steering wheel quickly.
- Short time from last alarm.
- Continuous line pressing or riding drive.

When the  indicator lamp is illuminated in blue, if there is no action mentioned above, and the vehicle deviates from the lane (for example, the vehicle deviates unexpectedly

from the lane due to driver's fatigue, distraction, or a phone call), the system will send a warning to the driver, and display the lane marking (red) on corresponding side for prompt through the instrument cluster, accompanied by a buzzer sound.

Steering assist

The corrective steering adjustment indication of lane departure warning system is triggered only when the assist mode is "Steering" or "Steering and warning".

When the instrument indicates the vehicle speed of greater than 65 km/h and the system detects at least a valid lane marking on one side, the  indicator lamp of the instrument cluster will turn green. This indicates that the system may intervene in turning of steering wheel for corrective steering adjustment. When only the lane marking on one side is detected, the system only works for lane keeping assist to that side.

When the  indicator lamp is blue, the system will not intervene in the steering wheel for corrective steering adjustment if the vehicle departs from the lane under one of the following conditions.

- Step on the brake pedal for deceleration with great braking force.
- Turn on the turn signal lamp on the

corresponding side.

- Turn on the hazard warning lamp.
- Turn the steering wheel quickly.
- Short time from last alarm.
- Continuous line pressing or riding drive.
- Hands-on reminder given by the system on the instrument cluster as the driver's both hands are off the steering wheel for a long time.

When the system intervenes in the steering wheel for corrective steering adjustment, the driver can feel the torque applied by the system to the steering wheel and the instrument cluster displays a corresponding lane marking (blue) prompt.

5. Driving Guide

Hands-on reminder



When the lane departure warning system detects that the steering wheel is out of the driver's hands for a long time, the system issues a hands-on reminder while the instrument cluster displays the icon above and an audible alarm is issued. This prompt only appears when the driver selects "Steering" or "Steering and warning".

The driver shall immediately hold the steering wheel immediately after receiving the hands-on reminder. Don't panic or turn the steering wheel fiercely. After the lane departure warning system recognizes that the driver is holding the steering wheel by detecting the torque manually applied to the steering wheel, the hands-on reminder disappears. Meanwhile, the lane departure warning system is automatically reactivated.

i NOTE

The condition that the driver's hands are lightly holding on the steering wheel may be misinterpreted by the system as the steering wheel out-of-hand. In this case, when the system issues a steering wheel hands-on reminder, the driver only needs to hold the steering wheel tightly or shake the steering wheel slightly, so that the system can detect the torque applied to the steering wheel. Afterwards, the hands-on reminder will disappear.

Other indications

When the system detects that the IFC is blind, a text reminder reading "IFC blocked" will pop up on the instrument cluster.

Usually, this is caused by dirty front windshield or the IFC exposed to low direct sunlight, etc. The lane departure warning system will not be damaged on that and it does not need to be overhauled.

The driver can try to turn on the front windshield washer and wiper for cleaning.

When the system detects a fault, the message "Please check LDW" will pop up on the instrument cluster, and the status indicator lamp  will light up in yellow. In this case, please go to the GAC Motor authorized shop for inspection in time.

Function limitations

The lane departure warning system may wrongly detect a lane marking or not detect any lane marking at all due to inevitable environmental factors and conditions even if it is activated and working. The system may become affected or inoperative under the following conditions:

- Poor visibility due to snow, rain, fog, spray, etc.
- dirty or foggy front windshield, or obstructed IFC on the front windshield.
- high ambient temperature around the IFC due to direct sunlight.
- glare caused by direct sunlight, oncoming vehicles, reflected light from road with accumulated water, etc.
- sudden changes in outdoor brightness, such as entering/exiting tunnels.
- headlamp not turned on at night or when the lighting is dim in tunnels.
- no lane marking, or difficulty in distinguishing the lane marking color from the road surface color.

- the lane marking not obvious, too fine, worn, blurred or covered with dirt and snow.
- too wide or too narrow lane.
- the number of lanes increased or decreased, or the lane markings complicated.
- more than two lane markings on the left and right sides of the vehicle.
- markings or objects resembling lane markings present on the road.
- isolation strips or other objects casting shadows on lane markings.
- short-term change of marking, such as ramp or expressway exit.
- driving on steep slopes or winding roads.
- being too close to the vehicle in front or driving of the vehicle in front blocks the lane marking.
- severe shaking of the vehicle.

Under the following conditions, the performance of the system may be affected while it intervenes in turning of steering wheel for corrective steering adjustment:

- vehicle overloaded.
- abnormal tire pressure.
- uneven road surface.
- strong crosswind.
- driver's modification of the parts related to vehicle control.
- Replace the vehicle control-related parts with non-original matching parts.
- Improper assembly of vehicle handling related parts.

NOTE

When the lane departure warning system intervenes in turning of the steering wheel for corrective steering adjustment, the driver may still turn the steering wheel to control the vehicle. When the torque applied by the system is found improper, the driver can control the vehicle to travel according to his intention when required.

CAUTION

- When the LDW detects an unintended deviation from the lane, it will send out a warning or intervene in the steering wheel for corrective steering adjustment. Neither panic nor turn the steering wheel fiercely.
- When the LDW detects that the driver's hands have been off the steering wheel for a long time, it will give a warning. Do not panic, or hit or shake the steering wheel unnecessarily. and instead, please hold the steering wheel and drive the vehicle as usual.
- When "Warning" is selected as the LDW mode, the system will not issue the steering wheel intervention and takeover prompt. When "Steering" is selected as the LDW mode, the system will not issue a warning.

5. Driving Guide



WARNING

- The LDW is only an auxiliary system and cannot actively control the vehicle to change lanes or keep lanes. The driver must always check the road conditions, hold the steering wheel and actively control the vehicle.
- Improper or careless use of LDW may cause accidents. Do not rely on LDW or try dangerous driving with the help of LDW.



WARNING

- LDW does not always recognize lane markings and lane edges. The system may wrongly identify or even don't identify a lane marking or a lane edge due to bad weather, poor night lighting, water or snow on road, damaged or blurry lane markings, or shade on roads.
- As a result, there may be missing triggering and false triggering of the function. Therefore, the driver must concentrate on observing the road and traffic conditions and drive carefully.



WARNING

- Protect the IFC against strong impact, moisture or heat; and never remove and refit any part without authorization. Do not place reflective objects on the instrument panel, which not only are easy to dazzle the driver but also may reflect the light to the field of view of the IFC, affecting normal operation.
- Do not color or coat the front windshield with any material not meeting the corresponding specifications. Any additional objects that negatively affecting the sight of the IFC may lead to improper operation of the system.
- Avoid impact on or modification of the bumper or vehicle body; otherwise the LDW system may operate abnormally.

WARNING

- When the system fails to detect the lane marking, or judges that the driver intentionally makes the vehicle deviate from the lane (such as when detecting a fast steering wheel rotation) or when the vehicle speed is less than 65 km/h, even if the vehicle deviates from or leaves the lane, the system will not give a warning or make steering intervention.
- The system can only adjust limited steering angle, so it can't promise that the vehicle will be driven back into the lane under any circumstances.
- The sound inside the vehicle or the noise outside the vehicle may prevent you from hearing the warning sound, so there is no guarantee that you can be reminded of the alarm given by the LDW under any circumstances.

5.4.8 Intelligent high beam control (IHC)*

The IHC system detects traffic and environmental factors in real time through an IFC sensor on the upper edge of the front windshield, and can automatically switch between the low beam and the high beam. For example, if the driver activates the IHC during driving on a road with poor lighting at night, the system will switch on the high beam automatically when it is detected that the operating conditions of high beam are met; the system will switch the headlamp from high beam to low beam when the vehicle meeting or too close following driving is detected.

Activating IHC

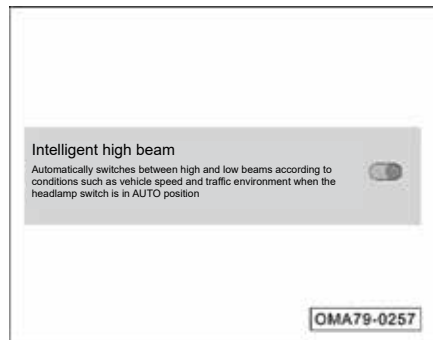



1. When the START/STOP button is set to "ON" position, activate this function by clicking the soft key  on the right side of "IHC" via "Settings → Body Accessories → Exterior Lighting → IHC" in the AV system.

NOTE

The IHC has the memory function, so that it will work in the state before last shutdown when the vehicle is restarted.

5. Driving Guide

2. Turn the lamp switch to the AUTO position and turn on the auto headlamp.
- After the IHC function is activated in standby mode, the indicator lamp  on the instrument cluster will be displayed in white if the conditions for turning on the high beam are not met, or the driver does not manually turn on the high beam.
 - When the IHC is turned on, the system will automatically switch to the high beam if the conditions for turning on the high beam are met, and the indicator lamp on the instrument will be displayed in blue .

Deactivating IHC

If one of the following conditions is met, turn off the intelligent headlight control function:

- Turn the lamp switch to a position other than AUTO.
- Deactivate this function by clicking the soft key  on the right side of "IHC" via "Settings → Body Accessories → Exterior Lighting → IHC" in the AV system.
- The vehicle is shut down.

NOTE

The high beam and high beam flash functions can be manually turned on/off at any time.

Disabling conditions of IHC

If the high beam request is suppressed, the IHC system will request the high beam to be turned off:

- The vehicle speed is below 15km/h.
- The fog lights are turned on or it is rainy or foggy weather.
- The wiper is turned on to the HI position for a period of time.
- The ambient brightness is relatively high.
- Street lights, near range cars ahead or incoming cars are detected.

The IHC system will inhibit the switching between high beam and low beam in the following situations. In the absence of the aforementioned situations, the system will recommend maintaining the current lighting state:

- The lateral acceleration or yaw rate is too high.
- High dynamic state (ABS or ESP activated).
- The vehicle speed is below 35km/h.

- Turn on the turn signal lamp.

Function limitations

When the IHC is activated, the automatic switching of high beam and low beam may be delayed or even unavailable when:

- The windshield surface in front of the IFC is covered with ice and snow, fog, dirt, stickers and other attachments.
- When there is a highly reflective object on a dimly lit street.
- The vehicle meets a pedestrian or a bicycle on a road with poor lighting or on a roadside.
- The light of the front oncoming vehicle is blocked by a crash barrier, a high bow-top road fence, a green belt, etc.
- When the vehicle in front is followed, the brightness of the rear lights of the vehicle in front is dim or does not meet the national standard.
- Encounter half-hidden oncoming vehicles at sharp turns, on mountain roads and at lowlands.
- Driving on slopes or bumpy roads.
- Drive in heavy rain, snow and fog.

- IFC is damaged or power supply is interrupted.

WARNING

IHC is a driver assist function, and it can help you to select the lighting way best suitable for the actual condition. The driver shall always be responsible for manual switching between the high and low beams under the traffic and environmental conditions.

- The intelligent high beam may not be able to correctly identify all driving environments and cannot operate properly in some environments.
- If the IFC is blocked by dirt, stickers, ice and snow, the IHC may become unavailable.

WARNING

- If the vehicle lighting system is changed (for example, the headlamp is modified), the IHC performance may also be degraded or the function may be unavailable.
- When meeting non-motor vehicles such as bicycles and electric bicycles or encountering pedestrians, the IHC system shall be shut down in time to prevent dazzling the other party.

5.4.9 Radar and IFC sensor*

Millimeter-wave (MMW) radar sensor

The MMW radar sensor is installed in the middle of the front bumper grille to monitor the traffic conditions and detect the front vehicles at a certain distance from the vehicle.

The radar sensor must be adjusted and calibrated under the following conditions:

- The fixing bracket of the MMW radar sensor is removed and then refitted;
- The MMW radar sensor is removed and then refitted;
- The toe-in or rear wheel camber is adjusted during the four-wheel alignment;
- The vehicle suffers a collision.

5. Driving Guide

NOTE

- Specific special tools and equipment shall be used for MMW radar sensor adjustment and calibration. If the MMW radar sensor needs adjustment and calibration, please go to the GAC Motor authorized shop for relevant operation.
- When the MMW radar sensor fails or is maladjusted, the ACC, ICA and FCW may be affected.

Special considerations on MMW radar sensor

The MMW radar sensor is installed at the front of the vehicle, and no obstacle shall be present in its detection area. Do not install the obstacles such as the license plate frame when installing the front license plate. Otherwise, the detection performance of the MMW radar sensor will be affected, resulting in failure of systems such as ACC, ICA and FCW.

CAUTION

- If the MMW radar sensor is dirty, blocked by the license plate frame, or covered by any foreign matters such as heavy rain, ice, snow, mud, the related functions of the radar sensor may not work and the instrument cluster will give disable/fault indication for these functions. To restore these functions to normal, clean the dirt and/or foreign matters.
- When there is strong reflection of the MMW radar ultrasonic wave (e.g: in a car park), related functions of MMW radar sensor may be affected.
- Prevent the front and surrounding of the MMW radar from being covered by objects like sticker, driving assistance lamp, license plate frame, etc.; otherwise the related functions of the radar sensor may be affected.
- It is recommended that the snow on the sensor is removed with a brush and the ice on the surface is removed with an insoluble de-icer spray.

CAUTION

- Maintenance of the front body of the vehicle may cause change in the radar sensor direction and affect related functions of MMW radar sensor (ACC/ICA/FCM). Therefore, please go to the GAC Motor authorized shop for service in time.
- If a MMW radar sensor is damaged or its direction changes, please deactivate the functions relevant to the MMW radar sensor (ACC/ICA/FCW, etc.), and go to the GAC Motor authorized shop for recalibration of the MMW radar sensor in time.
- The direction of the MMW radar sensor may change due to vibration, for example, when the area near the front bumper radar collides with the curb/flower bed. Change of the direction of the sensor may affect the performance of the functions dependent on the radar or even cause abnormal deactivation of these functions.

IFC

An IFC is installed on the upper part of the front windshield to detect the surrounding environment. It can identify pedestrians not blocked up to 80m away from the vehicle (in case that the environmental factors such as lighting are ideal) with a body height of not less than 0.8m. The front camera sensor must be calibrated under the following conditions:

- The front windshield or camera bracket is removed and replaced.
- The IFC sensor is removed and replaced.

NOTE

If the IFC fails, the ACC system, ICA system, LDW system, FCM system, and IHC system will all fail.

NOTE

- Special tools are required to be used for calibration of the IFC. If the calibration of the IFC sensor is required, please go to the GAC Motor authorized shop for relevant operation.
- When the IFC fails, or is maladjusted or blocked, the systems including ACC, FCM, LDW, ICA and IHC may be affected and will not work properly.

CAUTION

Poor lighting conditions, night, backlight, rainstorm, water fog, ice and snow or sludge may affect the IFC, resulting in the interruption or degradation of the functions of the FCW, ACC, ICA, AEB, LDW, and IHU. In serious cases, the function will be completely disabled, and the instrument will prompt intelligent driving assistance alarm messages such as "The forward radar is blocked", "The view of IFC is obstructed", "Please check LDW", "Please check cruise system", "Please check FCM", etc.

5. Driving Guide

CAUTION

The field of view of the IFC may be affected by obstructions, such as dust, sediment, water mist, icing, snow or sludge on the front windshield. In these cases, the LDW, FCM, ACC, ICA and IHC will be disabled. Please wipe the area near the camera on the front windshield, or turn on the defrosting and defogging function of the A/C. The functions can return to normal after the obstructions are cleared.

CAUTION

- If the interference of IFC is cleared, the PDS will work normally again.
- Low light conditions at sunset or night may affect the functioning of PDS. Never block the sight around the IFC with stickers or opaque objects; otherwise, the PDS may not work properly.
- Before driving, please check whether there is any obstacle in the area around the IFC.
- Keep the IFC sensor on the front windshield free from any obstacle.

5.4.10 Tire pressure monitoring system (TPMS)

The TPMS monitors the pressure and temperature of the tire, and displays them on the instrument cluster. In case of tire anomalies such as low/high pressure, rapid air leakage and high temperature, the instrument cluster will display an alarm message accordingly.

If the vehicle has not been used for more than seven days or the battery has been disconnected, when the ENGINE START/STOP button is in "ON" position, the tire pressure and temperature will be displayed as "---" on the instrument cluster, and after the vehicle speed reaches above 25km/h for several minutes, the real-time tire pressure and temperature will be displayed on the instrument cluster.

Alarm description

- If the tire pressure is higher than 330Kpa, the TPMS indicator lamp will come on, and the alarm message about high tire pressure will be displayed on the instrument cluster; when the tire pressure drops below than 300kPa, the fault is eliminated and the tire pressure warning lamp goes out.
- If the tire pressure is lower than 75% of the normal set value, the indicator lamp of the TPM system comes on and the alarm message on the instrument display indicates that the tire pressure is low; when the tire pressure (cold tire pressure) rises to the normal set value, the fault is eliminated and the tire pressure warning lamp goes out.
- If the tire pressure keeps dropping at a rate more than 30kPa/min, the TPMS indicator lamp comes on and the alarm message on the instrument cluster display indicates that the tire has air leakage; when the vehicle is powered on again, the fault is eliminated and the tire pressure warning lamp goes out.
- If the tire temperature is higher than 85°C, the TPMS indicator lamp lights up, and a warning message "High tire temperature" appears on the instrument cluster display; When the tire temperature drops to 80°C, the fault is eliminated and the tire pressure warning lamp goes out.

CAUTION

If you replace the tire pressure sensor in the tire or change the tire position, you do not need to go to the company's automobile sales service store for relearning and calibration under the condition of ensuring that the tire pressure sensor conforming to the vehicle model has been correctly installed. The TPMS will automatically complete the learning and calibration in the next few driving cycles.

NOTE

If the low tire pressure alarm does not disappear while you continue to drive as the tire pressure sensor is missing when a spare tire or a new tire has been replaced in another place. Please do not interpret that as abnormal tire pressure.

5. Driving Guide

5.5 Parking assist system (PAS)

5.5.1 Reversing parking aid (RPA)*

The RPA uses the RPA sensors to send and receive the ultrasonic waves reflected by the obstacle to measure the distance between the vehicle and the obstacle.

On and Off

- When the vehicle is reversing at a speed not greater than 10km/h with EPB released and shift lever set to "R" position, the RPA will start working.
- When the vehicle speed is greater than 12km/h or the shift lever is set out of "R" position, the RPA will stop working once the EPB is applied.

Dynamic view*



The dynamic schematic icon appearing on the display indicates the distance between the current vehicle and the obstacle. The outermost layer of the vehicle in the diagram is a green line, gradually becoming a yellow line, orange line, or red line inward. As the obstacle approaches the vehicle, the color lines will gradually gradient from the outermost layer to the inner layer.

Change of dynamic view is synchronized with that of the distance audible alarm.

Distance to detected obstacle			Alarm tone
Rear left sensor	Rear right sensor	Rear middle sensor	
90~120 cm	90~120 cm	90~150 cm	No alarm tone
60~90 cm	60~90 cm	60~90 cm	Slow and intermittent alarm sound
30~60 cm	30~60 cm	30~60 cm	Rapid intermittent audible alarm
< 30cm	< 30cm	< 30cm	Continuous audible alarm

Distance audible alarm

The audible alarm changes with reference to the distance between a detected obstacle and the rear bumper, and meanwhile, the color of activated sectors shown on the AV system display changes accordingly: If the vehicle approaches an obstacle, the system will issue an audible alarm, and the closer the vehicle approaches the obstacle, the shorter the alarm sound; When the vehicle is very close to an obstacle, the system will emit a continuous warning sound. If the vehicle continues to approach the obstacle at this moment, the system will not be able to detect the obstacle.

5. Driving Guide

Distribution of RPA sensors

Type 1

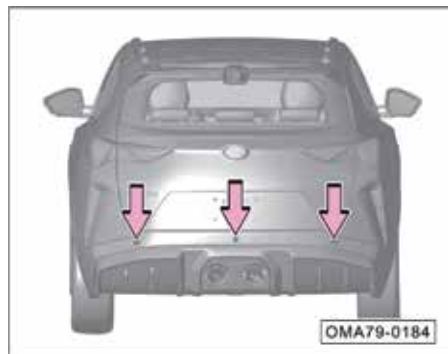

The radar sensors are installed on the rear bumper cover (applicable to vehicles equipped with RPA).

Type 2

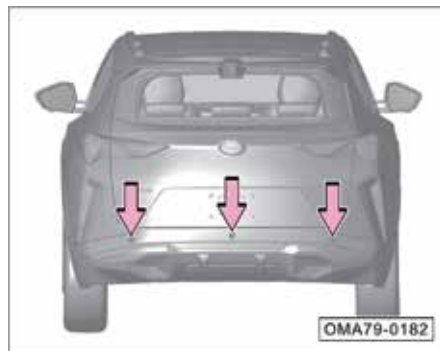

The radar sensors are installed on the rear bumper cover (applicable to vehicles equipped with RPA).

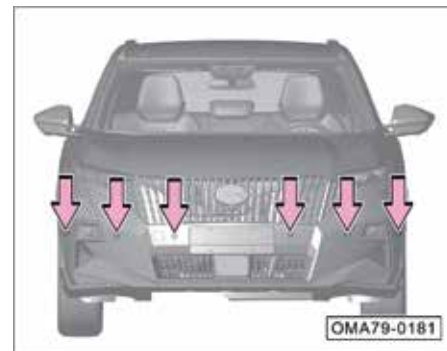

The radar sensors are installed on the front bumper cover (applicable to vehicles equipped with IFC and RPA).



The radar sensors are installed on the rear bumper cover (applicable to vehicles equipped with IFC and RPA).

CAUTION

- Always keep the surface of the radar sensors clean and never cover a radar sensor.
- Keep the radar sensors clean and protect them from freezing to ensure they operate properly.
- Clean the radar sensor surface with a piece of soft damp cloth to avoid scratching.

WARNING

- **The RPA cannot take the place of the driver's observation to the surrounding environment. The driver shall be concentrated and reverse safely according to the actual conditions.**
- **There is a blind spot when radar sensor is detecting obstacles. When reversing, the driver must pay attention to observation to avoid accidents.**
- **When the vehicle is reversing at a narrow place or on an uphill slope, the radar sensors may fail to detect railings, trees or slope surfaces, which is normal.**
- **When the reversing speed is high, the detection accuracy of the radar sensor reduces. Thus the reversing speed had better not to exceed 10km/h. When the RPA sends the continuous audible alarms, it indicates that the vehicle is extremely close to the detected obstacle, and reversing shall be stopped immediately to prevent an accident.**

5. Driving Guide



WARNING

- When a high-pressure cleaner is used, clean the radar sensors in snatches gently, with the nozzle at least 30cm away from the sensor.
- If water drops are on the surface of the radar sensors on the rear bumper, the sensitivity of the sensors will reduce. Wiping off them can restore the sensitivity of the sensors.
- The surface of some materials cannot reflect the signal from the radar sensors, so that the RPA sensors cannot detect such materials or people wearing the clothing made of such materials.





WARNING

- Noise sources outside the vehicle may interfere with the RPA sensors, preventing them from detecting any object.
- The radar sensor is a precision component, which shall not be removed, refitted and repaired without authorization. Otherwise, GAC will not assume any responsibility for the damage arising therefrom.

5.5.2 Around view monitor (AVM)*

The AVM system collects the left, right, front, rear images of the vehicle and integrate them into a 360° bird's-eye view of the surrounding environment, which is displayed on the AVM system display to provide the driver with information on the surrounding environment of the vehicle and to reduce blind spots during driving. In addition, it can take the parameters such as steering wheel angle and vehicle dimensions into consideration to predict the vehicle's motion trajectory, and the predicted trajectory can be superimposed on the panoramic image to provide the driver with full information on the vehicle's direction of traveling, helping the driver to determine whether stopping or driving at a low speed is safe.

On and Off

1. With the START/STOP button set to the "ON" position, the AVM can be activated/deactivated via the shift lever:
 - The AVM can be automatically turned on when the shift lever is set to the "R" position.
 - When the shift lever is set out of the "R" position and the driver does not perform any relevant operation, the instrument cluster indicates that system will be deactivated automatically after about 30s by default.
2. With the START/STOP button in the "ON" position, the AVM can be activated/deactivated by pressing the button:
 - Click the  icon in the menu bar of the AV system to enter the application menu interface, and click the "AVM" icon to enable the AVM; click the "x" soft key in the AVM interface to exit the AVM.
 - When the custom button on steering wheel* is set to "One-click AVM", the AVM can be activated by pressing the button  on the steering wheel.
3. The AVM can be activated/deactivated via "turn signal combination lever". When the START/STOP button is set to "ON" position:
 - Move the "Turn Signal Combination Lever" to the "Left Turn" or "Right Turn" position, and the AVM will be activated; Move the "Turn Signal Combination Lever" to the "Middle" position, and the system will automatically exit.
 - This function can be set to "on" or "off" through the "Settings" option on the AVM interface.
4. The AVM can be activated/deactivated automatically when "the radar sensors detect an obstacle". Turn the START/STOP button to "ON" position.
 - When the IFC detects an obstacle, the AVM will be activated automatically; when the detected obstacle disappears, the AVM will be deactivated automatically.
 - This function can be set to "on" or "off" through the "Settings" option on the AVM interface.
 - This function is only applicable to models with front radar configuration.

5. Driving Guide

Interface description

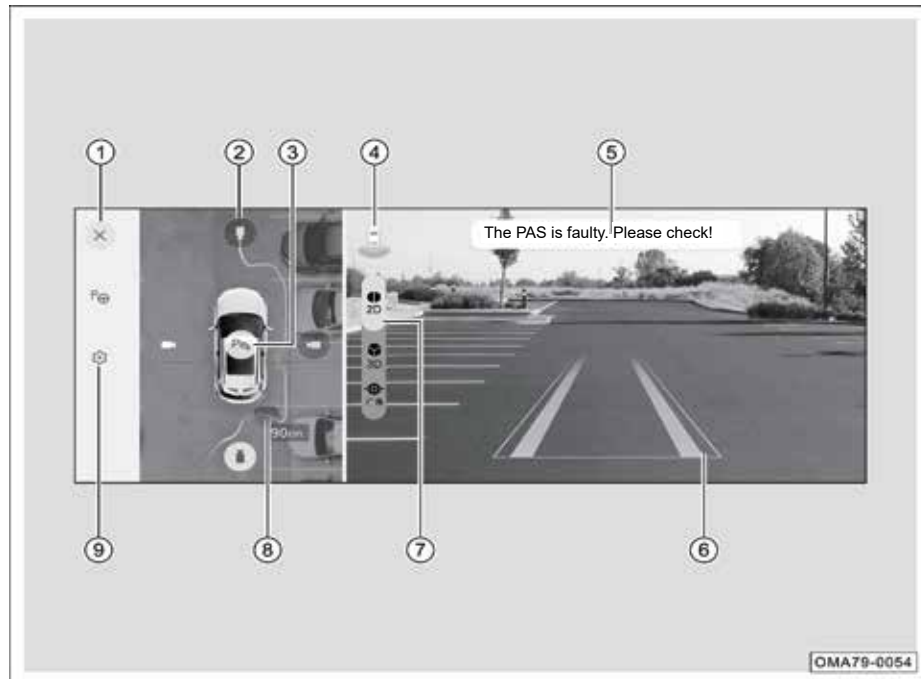

- ① Exit
- ② view switching soft button
- ③ Soft key of radar audible alarm switch*
- ④ Current view direction
- ⑤ Pop-up message window
- ⑥ Trajectory
- ⑦ 2D/3D/wide angle view switching (only applicable to models with 3D and wide angle functions)
- ⑧ Radar sensing area
- ⑨ Settings

i NOTE

The AVM interface and functions vary with vehicle models. Please refer to the actual vehicle.

AVM settings

1. Trajectory

- When the trajectory switch is turned on, the trajectory will be displayed in top view and 2D view; When the trajectory switch is turned off, the trajectory will not be displayed in the top view and 2D view.
- This function can be set to "on" or "off" through the "Settings" options on the AVM interface.

2. Transparent chassis*

- The transparent top view can be displayed after the vehicle is in motion.
- This function can be set to "on" or "off" through the "Settings" option on the AVM interface (there may be differences under various display conditions of AVM, please refer to the actual vehicle).

3. P gear exit

- If the P gear exit switch is set to "Immediate", the AVM interface will immediately exit when the gear is switched to P position; If the P gear exit switch is set to "30s Later", the AVM interface will exit 30s after the gear is switched to P position.

- This function can be set to "on" or "off" through the "Settings" option on the AVM interface (there may be differences under various display conditions of AVM, please refer to the actual vehicle).

4. Sensor-activated AVM*

- When the shift lever is in D or N position, the AVM interface will be automatically activated after the electronic handbrake is released or the front RPA detects an obstacle; The AVM will automatically exit after the obstacles in front disappear or the electronic handbrake is applied or the vehicle is powered off.
- This function can be set to "on" or "off" through the "Settings" options on the AVM interface.

5. Turn-signal-lamp-activated AVM

- When the turn signal lamp is activated, the AVM switch is turned on, and the vehicle speed is within 20km/h, the 2D left/right view or 3D left/right rear view of the AVM will be displayed after the left/right turn signal lamp switch is turned on, and the AVM interface will exit after the turn signal lamp returns to its original position.
- This function can be set to "on" or "off" through the "Settings" options on the AVM interface.

6. AVM*

- When a vehicle equipped with FAPA actively enters the AVM mode for the first time (via custom button/AV system soft key), if the memory is in 3D mode, a surround image of the vehicle will be displayed. Please refer to the actual vehicle for specific situations.
 - When a vehicle not equipped with FAPA actively enters the AVM mode for the first time (via AV system soft key only), a surround image of the vehicle will be displayed without the memory being in 3D mode.
 - This function can be set to "on" or "off" through the "Settings" options on the AVM interface.
- #### 7. One-click parking*
- In the AVM interface of AV system, if the system detects an available parking space near the vehicle, a pop-up message will appear indicating "Parking space is found, one-click parking is available". After the driver applies the brake to stop the vehicle, the "Start Parking" soft key will pop up on the AVM interface, which can be clicked to start parking.
 - This function can be set to "on" or "off" through the "Settings" options on the AVM interface.

5. Driving Guide

i NOTE

- When the AVM is turned on, the A/V system starts to display images taken around the vehicle, with some guide lines and radar prompts.
- If the vehicle speed is greater than 20 km/h during driving, the system will automatically be turned off.
- When the shift lever is not in "R" gear and the system activation time is longer than 30s, the system will automatically be turned off.
- If not fully enabled, the AV system will not function normally.

i NOTE

- When the shift lever is in the "R" position, a 2D single rear view is displayed in the image display area by default.
- When the shift lever is in a position other than "R", a 2D single front view is displayed in the image display area by default.
- The 2D and 3D display modes are provided with memory function (except for the default 2D rear view in R gear). If the last operation before exiting the AVM is in 2D mode, the 2D display will be defaulted by the system the next time entering the AVM.
- The pop-up message window is displayed only when there is a message, and disappears at other times.

i NOTE

- The radar audible alarm can be triggered after the radar audible alarm switch* is turned on, and it will not be triggered when the switch grayed out (the radar audible alarm switch * only appears when the radar is alarming, and is hidden when the radar is silent).
- In the wide angle interface, different camera views can be viewed, including "front wide angle", "rear wide angle", "front wheel", and "rear wheel".
- The AVM interface varies with model configuration. Please refer to the actual vehicle.
- When the left turn signal lamps are turned on, the image display area is switched to the 2D/3D single left view; when the right turn signal lamps are turned on, the image display area is switched to the 2D/3D single right view.
- The view angle can be manually switched by the "View Switch" soft key, and the corresponding view will be displayed in the image display area.

Layout of cameras



The front camera is installed under the front logo.



The left & right cameras are installed on the left & right exterior rearview mirrors.

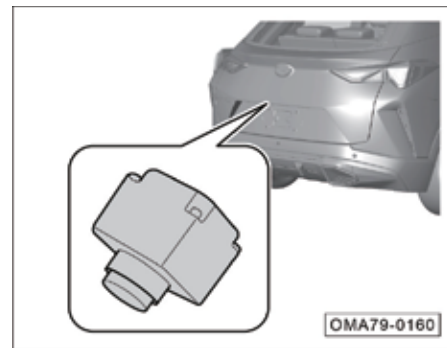

CCD is installed next to the license plate lamp.

5. Driving Guide

NOTE

To ensure the normal operation of the camera:

- Please keep the surface of the camera clean and free from foreign objects such as ice, snow, water, dust, etc.
- When foreign objects are found attached to the surface of the camera, please wipe it with a soft cloth or clean it with water (low water pressure), and maintain a distance of at least 30cm from the camera during cleaning.
- Do not use a high-pressure washer directly facing the camera for cleaning, and do not use abrasive or sharp objects to clean the camera.

CAUTION

Function limitation:

- When the camera cannot work properly, the function relying on the camera to provide recognition information will be limited, and the recognition range of the camera will also be limited, making it impossible to recognize targets beyond the recognition limit.
- When the external environment is poor, causing the camera's field of view to be unclear, the recognition ability of the camera will be affected.

CAUTION

The following situations may lead to the camera's failure to recognize the target, delay in recognition, or recognition errors:

- Poor lighting conditions (dim, low light) or poor visibility (caused by heavy rain, snow, dense fog, etc.).
- Camera facing the direct direction of light source, or insufficient light intensity.
- Severe changes in light (such as in and out of tunnels).
- Bad weather (such as heavy rain, snow, fog, incredibly high or low temperature) which cause interference with the operation of the camera.
- Camera surface adhered to by foreign objects such as ice, snow, frost, rain, mist, accumulated water, dust, etc. The uneven roads cause the subject vehicle to bump or shake.
- The camera's field of view is obstructed.

The above examples, warnings, and limitations do not fully cover all situations that affect the normal operation of camera sensors.



WARNING

- The camera is only for assist purposes and cannot fully function under all driving conditions or traffic, weather, and road conditions. When the vehicle is in a complex or poor environment, the driver shall drive carefully and always be responsible for driving safety.
- License plate frames or other objects cannot be installed on the front and rear license plates to avoid interference with sensors such as cameras and radars.



WARNING

It is prohibited to replace, modify, or add cameras without authorization. Only original or approved cameras from GAC Motor may be used, otherwise related functions may not be used properly, and GAC Motor will not assume responsibility for any problem caused thereby.

5. Driving Guide

5.5.3 Fusion automatic parking assist (FAPA)*

The FAPA can automatically search for parking bays on the left/right side of the vehicle and detect vehicles, pedestrians and obstacles around the vehicle.

After the user activates integrated parking, the system can automatically plan and calculate the parking trajectory, while controlling the vehicle's steering, speed, gear, etc. to automatically park the vehicle in or out of the parking space.

WARNING

- **This system only provides driver assistance function, and cannot replace the driver for parking, so the driver shall still take full responsibility for safe driving.**
- **Ensure that this system is used without violating road traffic regulations.**
- **Please find a legal, suitable and safe parking bay while using the system.**

WARNING

- **This system may be not always able to detect the objects on the parking bay. Therefore, be sure to visually inspect that the parking bay is suitable and safe.**
- **This system may be not always able to detect vehicles, pedestrians and obstacles; for vehicles, pedestrians and other moving objects that break in suddenly, this system also has a risk of failure to brake timely. Therefore, during use of this system, the driver should always pay attention to the surrounding environment of the vehicle and be ready to take over the vehicle at any time to ensure safe driving.**

WARNING

- **There are detection blind spots around the vehicle, especially on the side. If an obstacle enters the detection blind spot of the vehicle, the system cannot detect it and the driver needs to actively observe. If there is a risk of collision, the driver needs to take over the vehicle in a timely manner.**
- **During use of this system, the driver should pay attention to the switching of vehicle movement trajectory to avoid collisions between the vehicle and pedestrians, etc.**

System limitations

FAPA may involve safety risk and fail to operate normally in some cases including but not limited to the following:

- Narrow parking bays.
- Imperceptible obstacles in the parking bay and vehicle parking area: objects that cannot reflect ultrasonic sensor signals well, objects that are not within the visual and radar detection range, such as small animals, slender column objects, pointed objects, hollow objects, mesh objects, strip shaped objects, suspended objects, and low objects such as floor locks.
- Road slope greater than 10°.
- A large area of accumulated water or other water pools or mirrors that can form reflections in the parking area.
- Narrow vehicle passage or insufficient parking space.
- Poor visibility (due to night, heavy rain, heavy snow, heavy fog, etc.).
- Low curb out of the detection range.
- Ultrasonic sensors or AVM cameras contaminated or blocked by obstacles (such as mud, ice and snow).
- Installation position of the radar sensor or camera inconsistent with the design status.
- Bad weather (such as heavy rain, snow, fog, incredibly high or low temperature) which cause interference with the operation of the ultrasonic sensors and AVM cameras.
- Sensors are affected by other electrical equipment or devices which can generate ultrasonic waves.
- Too high or low tire pressure.
- Failure to recognize the parking bay due to unclear parking bay line, unclear corner spot of the parking bay line or blurred contrast between the parking bay line and other areas on the ground.
- Too thin parking bay line or irregular corner spot.
- Wrong recognition due to a vehicle/other obstacle in a relatively far position in the parking bay.
- Potholes in the parking area, such as water inlets without manhole covers, gullies, etc.
- The vehicle is removed or modified irregularly.
- Use of tire chains or spare tires.
- Vehicle equipped with a towing hook, and loaded items exceeding the vehicle size.
- Note: All the limitations are not described above.

5. Driving Guide

CAUTION

- After parking starts, do not touch the steering wheel or shift lever, or the FAPA will be deactivated.
- When this system is activated, please carry out the parking operation according to prompts on the center console display.
- If the vehicle speed exceeds 25km/h, the system cannot search parking bays correctly.
- The FAPA cannot always search a parking bay or park the vehicle successfully. If no parking bay is searched or the parking is not successful, the FAPA can be re-activated to try parking.
- Due to the mechanical clearance, tire pressure difference and other factors affecting the control accuracy, there will be certain errors in the final position of each parking in/pulling out.

NOTE

Solutions in case of fault or interruption:

- After the vehicle is faulty or the function is interrupted, the FAPA can be re-activated under normal circumstances.
- In some cases, the vehicle must be shut down and restarted. If the FAPA fails to be re-activated after the vehicle is restarted and others systems cool down, please go to the GAC Motor authorized shop for inspection.

Activating FAPA

Method 1:



- After the vehicle is started, click the "Intelligent Parking" soft key in the application menu of the A/V system to activate the FAPA.

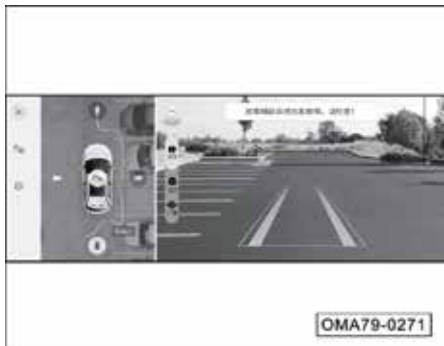

Method 2:



- After the vehicle is started, when the AVM is activated, click the icon  in the AVM interface of AV system to activate the FAPA (after a parking bay is found in the background, this icon will flash and be highlighted).

Method 3:



- After the vehicle is started, when a parking bay is found in the background, the icon  will be pushed in the status bar of the main interface of AV system. In this case, click the icon  to activate the FAPA.

Searching for parking bay

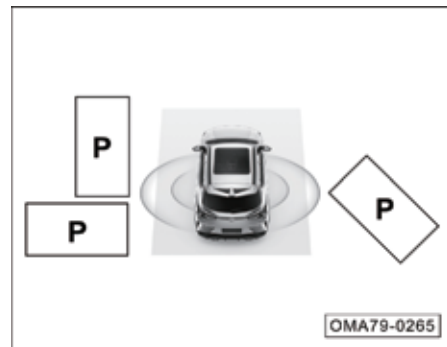

Please keep the vehicle side within 0.5m~2m from parking bays and maintain the vehicle speed not higher than 25km/h. In this case, the FAPA will automatically search for available parking bays.

The driver can also choose to activate the FAPA and then search for available parking bays according to the system prompts.

The FAPA can support the search for vertical, parallel and angled parking bays.

5. Driving Guide

Selecting pulling out direction

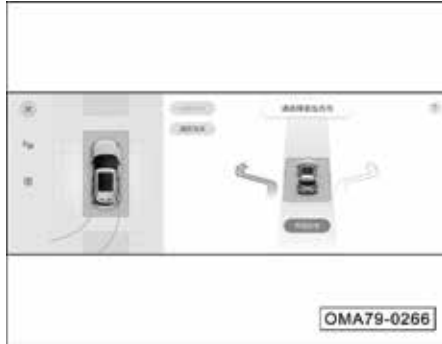

The automatic parking-out function can only be activated in parallel parking spaces when the vehicle is stationary and in P gear.

When the automatic pulling out function is activated, the driver can select the pulling out direction by clicking the arrow in the FAPA interface or turning the turn signal lamp lever.

i NOTE

- The FAPA has automatic parking in and automatic pulling out functions, whose activation is automatically judged by the FAPA.
- Due to system limitations, the FAPA cannot always search an available parking bay. If no parking bay is searched or an unavailable parking bay is searched, the FAPA can be re-activated for a second try.
- The length of a parallel parking bay required by the FAPA should be 5.4m or more; the width of a vertical parking bay required by the FAPA should be 3m or more.
- Keep the vehicle body 0.5~2m away from the parking bays while the system is searching for available parking bays.
- While the system is searching for available parking bays, try to keep the vehicle traveling direction parallel to the boundary lines of parking bays and keep driving straight.

Deactivating FAPA

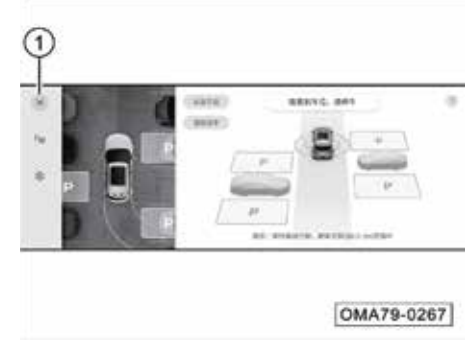

- Click the soft key ① in the upper left corner of the FAPA interface of AV system to deactivate the FAPA in any cases.

Suspending FAPA

After the APA system is activated, parking can be suspended in any of the following ways, and continue when the suspension condition disappears.

- Depress the brake pedal.
- Unfasten the driver's seat belt.
- Open the door.

Interruption cause

After being activated, the FAPA will be interrupted and deactivated in some cases including but not limited to the following. After being deactivated, the FAPA can be re-activated to try parking.

- The driver turns the steering wheel.
- The driver depresses the accelerator pedal.
- The driver operates the shift lever and presses the "P" button.
- The driver operates the EPB button.
- The engine hood is open.
- Pause timeout occurs.
- The pauses during parking exceeds the specified limit.
- The times of parking movements exceeds the specified limit.

- The total parking duration exceeds the specified limit.
- The parking space is limited.
- The gradient of the ground where the vehicle is located is too large.
- The vehicle is stuck and cannot move.
- TCS/ABS, etc. is activated or failed.
- The system is faulty.

5. Driving Guide

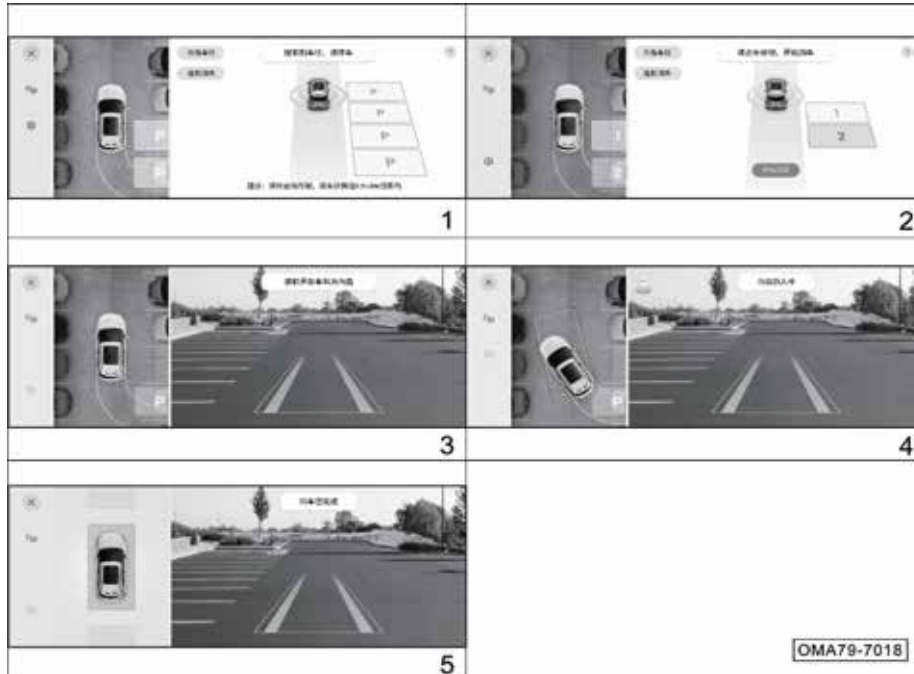

Operation instruction

Automatic parking in:

1. After the vehicle is started, the FAPA will be turned on, and it will automatically select the parking mode according to the current state of the vehicle and operate according to the prompts.
2. After parking bays are found, please park and follow the prompts to switch between different parking bays, then keep braking, and click "Start parking in" on the screen to activate the FAPA.
3. After parking is started, release the brake and steering wheel according to the prompts.
4. After releasing the brake and steering wheel, please wait for the parking to complete automatically, or you can manually choose to deactivate. In the process of activation, please pay attention to the surrounding environment and be ready to take over the vehicle at any time.
5. The parking is completed.

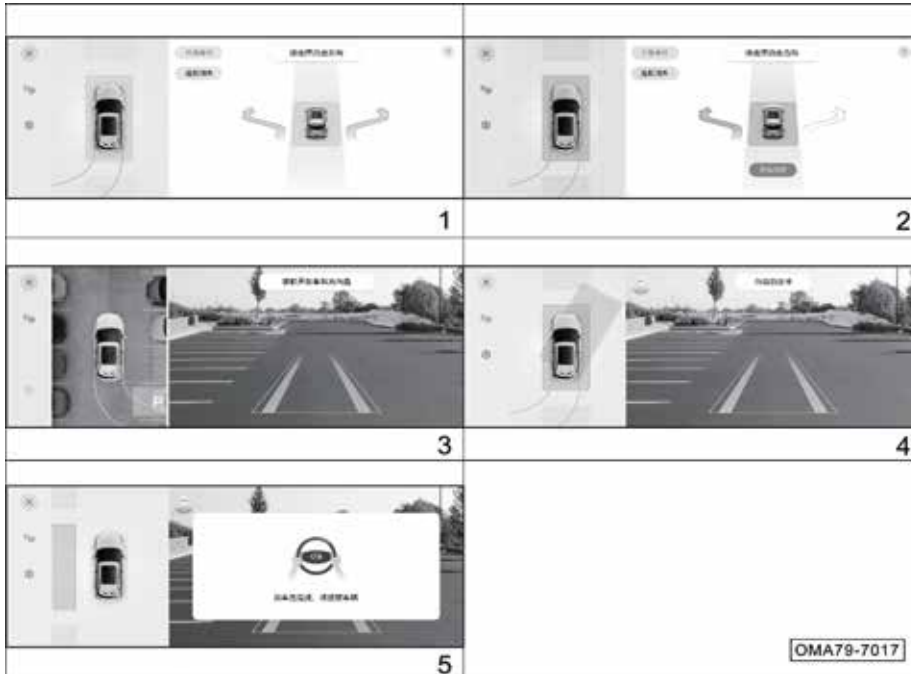

Operation instruction

Automatic parking out:

1. After the vehicle is started, the FAPA will be turned on, and it will automatically select the parking mode according to the current state of the vehicle.
2. Please follow the prompts to select the direction.
3. After parking is started, release the brake and steering wheel according to the prompts.
4. After releasing the brake and steering wheel, please wait for the parking to be completed automatically. During the activation, the driver should pay attention to the surrounding environment, and be ready to take over the vehicle at any time.
5. Please take over the vehicle after the parking is completed.

5. Driving Guide

5.6 Electric power steering (EPS)

Electric power steering system (EPS) is a power steering system that directly relies on the motor to provide auxiliary torque, and is mainly composed of a TAS, a motor, an ECU and a deceleration mechanism, etc.

The EPS ECU controls the torque provided by the EPS motor in real time by detecting the torque applied by the driver, the vehicle speed, the engine speed and other status signals of the vehicle to augment the steering effort in the best way so as to ensure the easiness of steering at a low speed and the stability of steering at a high speed, and to improve the driving comfort and vehicle safety.

EPS indicator lamp

With the START/STOP button in "ON" position, the indicator lamp  comes on, and goes out after the engine is started and the system completes the self-test, indicating that the EPS works normally.

If the indicator lamp  does not go out after the engine is started or comes on during driving, it indicates that the EPS is faulty, and in this case, an alarm message "Please check EPS." will be displayed on the instrument cluster display. In this case, it is required to park the vehicle in a safe place, and shut down and restart the engine. If the indicator lamp does not go out or comes on again while driving, stop driving, and contact the GAC Motor authorized shop for inspection.

Steering mode

There are three modes for turning effort of the steering wheel: Light, Comfort and Sport, where the turning effort of the steering wheel will be small in Light mode, moderate in Comfort mode, and large in Sport mode. The system is in Light mode by default. Please set the steering mode by selecting "Application Menu → Driving Mode → Current Mode Setting → Steering Wheel Turning Force" on the AV system display in situ when the steering wheel is released.

CAUTION

To prevent an accident, never set the steering mode during driving.

5.7 Driving skills

5.7.1 Pre-driving safety inspection

Routine inspection

- Check the tire for high/low pressure, cuts, bulges, damage or excessive wear.
- Check whether the wheel studs are missing or loose.
- Check whether the front lamps, brake lamp, tail lamps and turn signal lamps work properly; check the lighting direction of the front license plate lamp.
- Check that the seat belt is not worn or damaged; check that the seat belt is fastened securely after fastening the seat belt.
- Check that the free travel of the pedal is sufficient.
- Check whether the levels of coolant, engine oil, brake fluid and windshield washer fluid are normal.
- Check the battery terminals for corrosion or looseness, and check the battery case for cracks or deformation caused by expansion.
- Check for leakage of fuel, engine oil, water or other fluids under the vehicle, and pay attention that water drip found after A/C operation is normal.

Inspections after starting/during driving

- Check whether the instrument cluster works properly; check whether any indicator lamp comes on or any alarm message is shown, etc.
- Check whether all controls (such as the lamplight combination, wiper combination and defrost switches) work properly.
- Check that the vehicle does not deviates to one side during braking on a road without safety risks.
- Check for other anomalies, such as part looseness, leakage and unusual noise.

5.7.2 Driving during running-in period

In order to prolong the service life of the vehicle, the vehicle shall be subject to running-in of certain mileage before it is brought into use. Please comply with the following rules in the running-in period:

- The mileage in the running-in period shall be 1500km.
- Choose roads in good condition and drive it at reduced load and limited speed.
- Do not start the engine with full throttle or drive with harsh acceleration.
- Avoid emergency braking in first 300 km.
- Strictly follow the operating procedures and make sure that the engine has reached normal operating temperature. Do not change the oil before regular maintenance.
- Carry out daily maintenance of the vehicle carefully; check and tighten the external bolts and nuts frequently; check the sound and temperature changes of the assemblies generated by operation and adjust them timely.

5. Driving Guide

Engine running-in

The mileage in the running-in period of a new engine shall be 1500km. Do not perform the following operations within the first 1000km of driving:

- Keep the vehicle speed no more than 3/4 of the maximum allowable speed.
- Do not drive the vehicle with full throttle.
- Avoid running the engine at high speed.
- Do not tow any trailer.

Within 1000km-1500km, it is allowed to increase the engine & vehicle speeds gradually to the maximum allowable range.

The internal frictional resistance of the engine at the beginning of running-in is much greater than that after running-in, and all the moving parts of the engine can have the best fitting after running-in.

After fully running in, both the service life and the fuel efficiency of the engine can be improved.

Running-in of tire and brake lining

Within the first 500km of driving, drive the vehicle at a moderate speed to get the new tires run in fully.

Within the first 200km-300km of driving, the brake linings have not reach the optimal friction condition, so please drive at a low speed and avoid emergency braking as much as possible.

WARNING

- **New tires and brake linings without running-in do not have the best adhesion and friction. Therefore, drive the vehicle cautiously within the first 500km to get the tires fully run in to prevent accidents.**
- **Newly replaced brake lining shall be run in according to the above requirements as well.**
- **During driving, keep an appropriate distance from other vehicles to prevent emergency braking, as the new tires and brake linings have not been fully run in at this time and if an emergency braking is applied, a traffic accident is likely to occur.**

WARNING

- **If the brake is damp, frozen or the vehicle runs on a salted road, the braking effect will be reduced.**
- **The brake shall be applied according to the road and traffic conditions. Do not step on the brake pedal unnecessarily to overheat the brake, resulting in too long braking distance and excessive brake wear.**
- **Do not coast the vehicle with the engine shut down. As the brake booster does not work, the braking distance will be greatly increased, which is liable to cause accidents.**

5.7.3 Driving essentials

Precautions under various road conditions:

- When the vehicle is driving on a road with crosswinds and gusts, please decelerate in advance and control the speed and steering wheel.
- Avoid driving on sharp-edged objects or other road obstacles, otherwise it may cause serious damage such as tire burst.
- Reduce the speed and drive at a low speed while driving on a bumpy or uneven road; otherwise the chassis may be scratched, which result in vehicle damage.
- When the vehicle is being driven downhill, decelerate in advance; avoid emergency braking, otherwise the brake system will overheat or be worn prematurely.
- When the vehicle is running on a slippery road, be careful during accelerating or braking; avoid sudden acceleration or emergency braking, otherwise it is likely to cause wheel slip.
- When the vehicle is running on an icy or snowy road, drive at a low and constant speed; avoid sudden acceleration or emergency braking and install tire chains for the wheels when necessary.

Precautions while driving over a water-logged road section:

- 1 Before driving over a water-logged road section, check the depth of water, which shall not be higher than the lower edge of the vehicle body.
- 2 Before driving through water, switch off the A/C before starting, decelerate and then gently depress the accelerator pedal without release to drive over the water-logged road section at a stable and low speed.
- 3 Do not stop the vehicle, reverse or shut down the engine in water.
- 4 After the vehicle is successfully driven through the water-logged road section, gently depress the brake pedal for several times to evaporate the moisture on the brake discs so as to restore the braking performance as soon as possible.

i NOTE

The brake linings and brake discs are soaked in water while the vehicle is washed or driven over a road with deep water logging, and the braking effect will be greatly reduced; the braking distance will be longer than usual and the vehicle may be deviated to one side, and the parking brake cannot hold the vehicle still. In this case, it is recommended to drive the vehicle at a low speed and constantly depress the brake pedal slightly to remove residual moisture in the brake to recover the braking effect to the normal level. And then, normal driving can be resumed.

Driving essentials in winter

- 1 Check if the coolant is in good condition and if it has good anti-freeze effect as follows:
 - Fill the cooling system with the coolant of the same type as the original one according to the ambient temperature.
 - Adding unsuitable coolant may cause damage to the engine.
2. Check the battery and cables as follows:

5. Driving Guide

- A low temperature in chilly days will reduce the capacity of battery, and therefore, fully charge the battery for start-up in winter.
- 3. Prevent the door lock from being frozen by ice and snow as follows:
 - Spray some de-icer spray or glycerin into the door lock hole to prevent the door lock from being frozen.
- 4. Use washer fluids containing antifreeze:
 - These products are available at GAC Motor authorized shop.
 - The mix ratio of water to antifreeze shall comply with the manufacturer's instructions.
- 5. Avoid accumulated ice and snow beneath the mudguard:
 - Accumulated ice and snow beneath the mudguard may result in difficult steering. Stop the vehicle regularly to check for accumulated ice or snow beneath the mudguard while driving the vehicle in severe cold winter.
- 6. It is recommended to bring some necessary emergency items according to the road conditions, such as:
 - Tire chains, a window scraper, a bag of sand or salt, a flashing light, a plough staff, connecting cables, etc., which are recommended to be placed in the vehicle.
- 7. In cold winter (especially in northern China), avoid starting the engine frequently and shutting down the engine immediately after a short-time start. If the engine is often in an alternating heat & cold cycle, the condensed water is likely to form in the engine, and when the condensed water adheres to the engine oil, it may give an illusion of water-in-oil emulsion, and after the engine is restarted and warmed up, this illusion will be shattered; in addition, please change the oil regularly as required in the Warranty Manual

5.7.4 Efficient use of vehicle

- Before driving, make sure that the parking brake is completely released and the parking brake indicator lamp is off.
- Maintain sufficient tire pressure, as a too low tire pressure can cause premature tire wear and higher fuel consumption.
- Ensure that the wheel alignment is accurate. Otherwise it will cause premature tire wear, increased engine load and higher fuel consumption.
- Do not overload the vehicle, and unload unnecessary items from the vehicle, as excessive load will increase the engine load and the fuel consumption thereafter.
- Accelerate the vehicle slowly and smoothly to avoid rapid acceleration.
- Avoid roads with traffic jams as much as possible, as driving in traffic jam will increase the fuel consumption.
- Follow the instructions of traffic lights or maintain a safe distance with other vehicles while driving to avoid unnecessary stop or emergency braking, so as to save fuel and reduce wear on the brake system.

- When the vehicle is running, do not step on the brake pedal, as it will cause premature wear, overheating of the brake friction pad and waste of fuel.
- When driving, select good road surface. If driving on uneven roads, control the vehicle speed to avoid collision or scratches.
- If the chassis is stained with objects such as excessive dirt, clean them in time to reduce the vehicle's weight and prevent corrosion.
- Perform regular maintenance on the vehicle to maintain its optimal working condition, as dirty air cleaner, spark plugs, oil, and grease will reduce the engine performance and increase fuel consumption.
- When starting the engine at a low temperature, drive slowly for a few minutes, and ensure the engine is warmed up before acceleration.
- Do not open windows when driving at high speed.
- Properly use the A/C, etc.
- In case of parking for a long time, please shut down the engine to avoid wasting fuel due to long time idling of engine.

5.7.5 Fire prevention

In order to prevent vehicle fires, pay attention to the followings during use:

1. Never store flammables or explosives in the vehicle:
 - In hot summer days, the inside temperature of vehicles parked in the sun can be as high as 70°C or more. If flammables or explosives such as lighters, cleaning agents and perfumes are stored in the vehicle, fire and even explosion will be likely to occur.
 - Items with risk of fire such as lithium batteries or power banks left in the vehicle by passengers are also likely to cause fire.
2. Make sure the cigarette butts are completely extinguished after smoking:
 - If the cigarette butts are not completely extinguished, fire may be caused.
3. It is recommended to regularly drive to the GAC Motor authorized shop for inspections:
 - Also subject all electric lines of the vehicle to regular inspections. Specifically speaking, check whether the connectors, insulation, and fixing positions of electrical components and harnesses are normal, and handle any problems found during inspection in a timely manner.

4. Never modify the electrical circuits or install additional electrical components:
 - Installation of additional electrical consumers (such as high-power audio device) will cause excessive load on the electrical line, causing overheating and even fire of harnesses.
 - Never use fuses that exceed the rated specifications of the electrical consumer or other metal wires to replace the fuses.
5. Precautions for driving:
 - During driving and parking, especially in summer, be sure to check if there are flammables such as hay, dry branches, leaves and wheat stalks under the vehicle, as they may be ignited by the components heated after long-time driving, such as engine exhaust pipe.
 - Do not park the vehicle in places involving serious rat infestation, such as garbage dumps, and do not place items that attract rats, such as snacks in the vehicle, because rats will bite through the harnesses and a fire will be caused therefrom.

5. Driving Guide

6. Always place a lightweight fire extinguisher in the vehicle, and know its operation method:
 - In order to ensure the safety of the vehicle, place a fire extinguisher in the vehicle, and regularly check and replace it; at the same time, be familiar with the operation method of the fire extinguisher, so as to be prepared for handling any unexpected fire accident.

6.1 Maintenance instructions

Safety precautions

To avoid potential hazards, please read this section before work and confirm that you have the necessary tools and techniques.

- Make sure that the vehicle is parked on a level ground, shut down the engine and apply the parking brake.
- When cleaning parts and components, use the commercially available de-greaser or parts cleaner, instead of gasoline.
- Keep lit cigarettes, sparks, and open flames away from batteries and all fuel system related components.
- When working on batteries or with compressed air, wear goggles and protective clothing.

WARNING

Incorrect vehicle maintenance or driving the vehicle before the problem is solved may cause a traffic accident, resulting in serious injury or death.

Potential hazards of the vehicle

- Carbon monoxide: Carbon monoxide in the exhaust gas emitted by the engine is a toxic gas. Be sure to operate the engine in a well-ventilated place.
- Scald: The engine and exhaust system generate high temperature during operation, which is liable to cause scalding. Therefore, the relevant parts can be touched only after the engine and exhaust system cool down.

CAUTION

This section lists some of important safety precautions. We cannot list all the dangers you may encounter during maintenance work.

6.2 Interior maintenance

Cleaning and maintenance of instruments and plastic parts

Clean the surface of instruments and plastic parts with a clean soft cloth and clean water.

If it cannot be cleaned, it is required to use a special solvent-free plastic cleaning agent for cleaning.

CAUTION

Solvent-based cleaning agents can damage plastic parts.

WARNING

It is forbidden to use cab sprays and solvent-based cleaning agents to clean the surface of the instrument panel and airbag assembly. Otherwise, it may loosen the surface and trigger the airbag, which may cause serious injury to occupants.

6. Operation and maintenance

Cleaning and maintenance of carpet

Vacuum the dust on the carpet frequently.

Scrub the carpet regularly with detergent to keep it clean.

CAUTION

Please perform the cleaning in strict accordance with the operating instructions of cleaning agents.

WARNING

It is forbidden to add water to the foam cleaner. The carpet shall be kept as dry as possible.

Cleaning and maintenance of leather*

- Vacuum the dust.
- Clean the leather with a clean soft cloth and clean water.
- Wipe the leather dry with another dry soft cloth.
- If the cleaning methods described above are not enough to clean stains, please combine these methods with special leather cleaning soap or detergent.

CAUTION

If a leather stain remover is used, wipe it dry with a soft dry cloth as soon as possible.

WARNING

Never leave a soft cloth wet with leather stain remover on any part of the interiors for a long time. Avoid discoloring or breaking the resin or fibers of interior fabrics.

Cleaning and maintenance of seat belts

- Pull the seat belt out slowly and keep it being extracted.
- Remove dirt from the seat belt by using a soft brush and neutral soapy water.
- After seat belts dry completely, retract the seat belts.

CAUTION

- Wait till the seat belts dry completely before retracting them. Otherwise, seat belt retractors may be damaged.
- Regularly check all the seat belts in the vehicle to ensure that the seat belts are clean and avoid hindering the normal operation of seat belts.



WARNING

- **If the seat belt webbing, connectors, retractor mechanism or buckles are damaged, please go to the GAC Motor authorized shop for replacement as soon as possible.**
- **For the overhaul of an accident vehicle, seat belts must be replaced, no matter whether they are damaged or intact.**
- **Avoid foreign objects or liquids entering the seat belt buckles, which may result in the buckles and seat belts not working properly.**
- **Under any circumstances, it is forbidden to remove or modify seat belts without authorization.**
- **It is forbidden to use chemical cleaning agents to clean the seat belts, for fear of damaging the seat belt webbing and impairing the function of seat belt.**

Cleaning and replacement of filters

The vehicle is equipped with an air cleaner, an A/C filter, an oil filter, a fuel filter, etc. They aim to filter gases or fluids. If they are too dirty or clogged, the normal operation of corresponding systems will be affected. Therefore, it is recommended to regularly clean or replace the filters at the GAC Motor authorized shop according to the provisions of the Warranty Manual.

6.3 Exterior maintenance

Vehicle washing

Washing the vehicle frequently helps to protect its appearance.

Vehicle washing shall be performed in a cool place, rather than under direct sunlight. If the vehicle is left in the sun for a long time, wait till the vehicle body surface cools down before washing the vehicle.

When using an automatic vehicle washer, be sure to follow the instructions of the operator of the automatic vehicle washer.



WARNING

The vehicle power switch must be set to “OFF” position before vehicle washing.

6. Operation and maintenance

CAUTION

The paint surface of the vehicle body is strong enough to withstand the washing of the automatic vehicle washer. However, it is important to pay attention to the effects on the paint surface. The structure of the automatic vehicle washer, the cleaning agent, the filtering state of the clean water, and the type of wax solvent that do not meet the requirements may cause damage to the paint surface.

Manual vehicle washing

- Rinse the vehicle with plenty of water to remove floating dust.
- Prepare a bucket of water and add a special cleaning agent for vehicle washing to it.
- Gently scrub the vehicle with a soft cloth, sponge or soft brush and rinse it several times from top to bottom.
- Rinse the parts such as wheels and door sills at last. Replace sponges or soft cloth while washing the vehicle.
- After scrubbing, rinse the vehicle thoroughly with plenty of water.
- After washing, carefully dry the paint surface of the vehicle using a soft towel or antelope skin.

CAUTION

When the vehicle body has dirt such as asphalt, it needs to be cleaned with a special cleaning agent, and then rinsed with clean water to avoid damaging the surface finish of the vehicle body. Check the body for paint peeling and scratches while wiping the body. If any, drive to the GAC Motor authorized shop for touch-up.

When using a steam cleaner or a high-pressure cleaner to wash the vehicle, be sure to be very careful. Be sure to wash the vehicle in accordance with the operation instructions and requirements of the steam cleaner or high-pressure cleaner. Pay attention to the working pressure, temperature and spraying distance:

- When using a steam cleaner or a high-pressure cleaner to wash the vehicle, keep a sufficient water spray distance from the vehicle, and ensure the temperature does not exceed 60°C.

- Do not wash a radar sensor or a parking assist camera with a high-pressure cleaner for a long time; when washing the radar sensor or parking assist cameras, keep the water spray distance more than 30 cm.

WARNING

- **When washing the vehicle manually, pay attention to personal safety and beware of angular parts at the bottom of the vehicle to avoid being scratched.**
- **When washing the vehicle, pay special attention to the bottom of the vehicle and the inner side of wheelhouses. Do not hurt hands and arms with sharp parts.**
- **Never spray water directly into the engine compartment when washing the vehicle. Otherwise, it will affect the service life of various parts and components in the engine compartment.**

Waxing

Regular waxing can protect the paint surface of the vehicle body and keep the vehicle body clean. In order to effectively protect the paint surface of the vehicle body, it is recommended to apply high-quality hard wax once a year to protect the paint surface against corrosion by external bad environments and to resist light mechanical scratch.

Be sure to wipe the appearance of the entire vehicle dry before waxing. Before waxing the vehicle, please select a high-quality wax protectant. High-quality wax protectant generally falls into the following two types:

- Body wax: Wax used to protect the paintwork from damage caused by adverse external environment such as sun exposure and air pollution. This type of wax is generally used for new vehicles.
- Polishing wax: Wax used to restore the paintwork that has been oxidized or has lost its luster. This type of wax is generally used to restore the gloss of paint surface.

Cleaning and maintenance of external plastic parts

External plastic parts are generally washed with clean water, soft cloth and soft brushes. If they cannot be cleaned, please use the special solvent-free plastics cleaner approved by our company.

CAUTION

Do not use solvent-based cleaning agents when washing plastic parts. Otherwise, it is easy to damage the plastic parts.

Washing of window glasses and rearview mirrors

Clean the window glasses and rearview mirrors with alcohol-based glass cleaner, and then wipe the glass surface dry with a clean, lint-free soft cloth or antelope skin.

After curing the surface of the vehicle body, remove the wax residue on the glasses with a special cleaning agent and cleaning cloth. Avoid scratching the wiper blades.

Remove snow from the windows and rearview mirrors using a small brush.

Remove accumulated ice using de-icer spray. An ice shovel can also be used, but special care must be taken to avoid damage to the components, and ice must be shaved in the same direction.

6. Operation and maintenance

CAUTION

- It is forbidden to scrape the surface back and forth.
- It is forbidden to remove ice and snow from the windshields and rearview mirrors using warm water or hot water. Otherwise, the windshields may burst.
- If there are residual objects such as rubber, grease and silicone on the glass, they must be removed with a special window cleaner or silicone cleaner.

Cleaning and maintenance of wiper cover

Try to avoid parking the vehicle under a tree frequently/for a long time. In case of leaves or other debris on the surface of the wiper cover, please clean them in time.

Cleaning of wiper blades

- Set the START/STOP button to the "ON" gear and then to the "OFF" gear.
- Move the wiper combination switch to the "MIST" position within 10 s. The wiper arm will stop after running for half a circle.

- Raise the wiper arm and carefully wipe off the dust and dirt on the wiper blade with a soft cloth.
- After cleaning, gently place the wiper arm back to the windshield.
- When the START/STOP button is set to "ON" position, the wiper arm will automatically return.

CAUTION

- Be careful when lowering the wiper arm to prevent it from falling and hitting the windshield instantly.
- The wiper blades are coated with a layer of graphite which makes the wiping operation smooth and does not produce scraping noise. Solvent-based cleaning agents, hard sponges and sharp objects can damage the graphite layer. Damaged graphite layer will increase the wiping noise of the wiper, and the wiper shall be replaced in time.
- In winter or cold conditions, it's important to check whether the wiper blade is frozen with the windshield before using the wiper. If so, perform de-icing first. Otherwise, the wiper blade and wiper motor will be damaged.

Maintenance of sealing strips

Frequent and proper protection of the rubber sealing strips of the doors, windows and other parts of the vehicle is intended to maintain their flexibility and prolong their service life. Such protection can also improve the tightness, make the door easy to open, reduce the impact sound of closing the door, and prevent freezing in winter.

When performing maintenance on sealing strips, remove dust and dirt from surfaces using a soft cloth. Apply special protective agent to rubber sealing strips regularly.

Cleaning and maintenance of wheels

Regularly remove anti-skid salts on the wheels and debris on the brake linings, which can keep the wheels aesthetic, maintain the surface smooth and prolong the service life of wheels. It is recommended to perform the following operations regularly:

- Remove anti-skid salts on the wheels and debris on the brake linings using acid-free wheel cleaner every two weeks.
- Apply high-quality hard wax to the alloy wheels every three months.

CAUTION

- It is prohibited to maintain the wheel surface with vehicle polish or other abrasives.
- The wheels with damaged protective coating on surface must be repaired in time.
- Using a high-pressure cleaner may cause permanent visible or invisible damage to the wheels, resulting in serious injury or death.
- It is forbidden to use cluster head nozzles to spray the tires. Otherwise the tires will be damaged, causing traffic accidents.

6.4 Inspecting and adding fluids

6.4.1 Fuel

As the amount of fuel decreases when the vehicle is running, the fuel gauge scale will gradually decrease. => See page 39

When the fuel level is too low,  the yellow indicator lamp flashes, and the instrument cluster will give an alarm message. At this time, fuel shall be added as soon as possible.

NOTE

Fuel grade: 92# and above high-quality lead-free gasoline

Adding fuel



- Pull up the fuel tank cap release handle  to make the fuel tank cap pop up outward.

6. Operation and maintenance

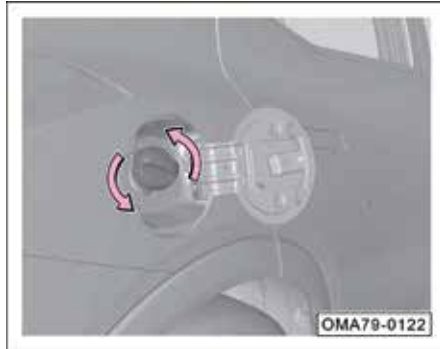

- Open the fuel tank cap completely, and slowly unscrew the fuel filler cap counterclockwise as arrowed. Keep the fuel filler cap at the original place for a while before it is unscrewed completely to allow fuel tank to release the fuel vapor pressure inside, and then remove the fuel filler cap.



- Suspend the filler cap at the inner side of the fuel tank cap and start adding fuel.
- After adding the fuel, tighten the fuel filler cap ① clockwise until a "click" sound is heard, indicating that the fuel filler cap has been completely tightened.

i NOTE

This model complies with China VI emission standards. The fuel supply system of China VI is designed with a closed fuel and gas recovery system. During refueling, the fuel gun switch may be triggered due to high ambient temperature or high fuel flow rate, and the fuel gun is switched off when the fuel tank is not filled fully. This is a normal phenomenon. At this time, the refueling speed shall be slowed down.

👁 CAUTION

- Low-grade fuel or substandard fuel may damage the engine or make the engine fail to meet performance requirements.
- When the fuel level is below 1/4, please refuel in time to avoid the vehicle breaking down due to insufficient fuel supply on slopes.

CAUTION

During refueling, insert the fuel gun into the deepest part of fuel filler pipe. When the fuel gun is switched off for the first time, it is recommended not to continue refueling to avoid fuel spillage caused by excessive refueling.

WARNING

- **At any time, be sure to shut down the engine when refueling, and pay attention to open flames and fire.**
- **Please avoid contact of fuel with skin or clothing.**
- **Please refuel the vehicle according to the vehicle fuel grade. If fuel not complying with the regulations is added accidentally, do not start the engine. Please contact the GAC Motor authorized shop immediately for treatment.**

6.4.2 Engine oil

Function of engine oil

Engine oil has functions such as lubrication, sealing, cooling, anti-rusting and cleaning.

Specifications of engine oil

The engine has been filled with high-quality engine oil, which can be used in the year-round climate except for extreme cold weather before delivery.

When purchasing engine oil, please check whether the specifications indicated on the outer packaging of the engine oil are suitable for the engine of this vehicle.

NOTE

Oil grade:

- API SN/ILSAC GF-5.

Oil viscosity:

- SAE 0W-20.

NOTE

- Be sure to go to the GAC Motor authorized shop to change the oil according to the period specified in the Warranty Manual.
- If the vehicle is running under severe conditions, fuel with high sulfur content is used, engine idles for a long time (e.g., a taxi), the vehicle is driven in a high-dust area, the vehicle often tows a trailer, or the vehicle is used in an alpine area, the maintenance cycle shall be shortened and the maintenance times shall be increased.

WARNING

Always use the engine oil approved by our company. Otherwise, the ensuing engine damage will not be covered by the warranty.

6. Operation and maintenance

Engine oil pressure warning lamp

When driving, if  the warning lamp comes on, be sure to stop the vehicle in a safe place and shut down the engine. After the engine cools down, check the oil level.

If the engine oil level is normal, but the warning lamp is still on after the engine is started, do not continue to start the engine. In this case, contact the GAC Motor authorized shop timely for inspection.

WARNING

- Ignoring the warning lamps and related warning instructions may damage the engine.
- The low oil pressure warning lamp can not indicate the oil level, and the oil level must be checked regularly.

Inspecting the oil level

Be sure to check the oil level regularly. Park the vehicle on a level ground, apply the park brake, and shut down the engine. After the engine cools down, open the engine hood and check the oil level.

NOTE

While checking the oil level, ensure the engine is cold.

WARNING

- Be extremely careful while working in the engine compartment.
- The engine compartment is a high-risk area. Be sure to read and follow the relevant warning instructions carefully before opening the engine hood.

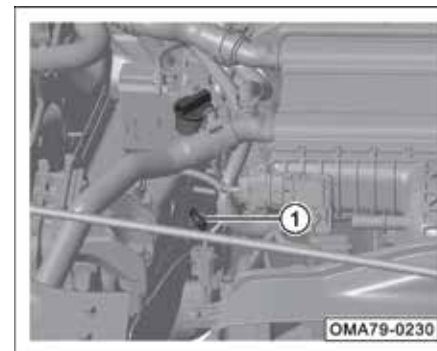

- Pull out the oil dipstick.

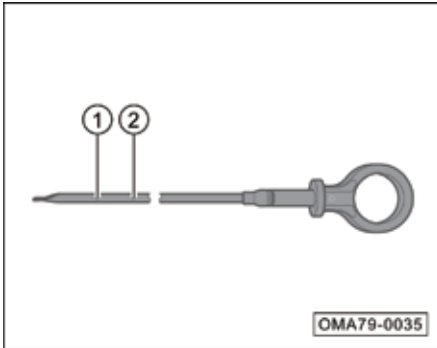

- Wipe off the oil stains on the dipstick using a clean cloth, and then insert the oil dipstick to the end.
- Pull out the oil dipstick again to read the measured oil level: The oil level shall be between the minimum scale mark ① and maximum scale mark ②.
- If there is too little engine oil, please add engine oil in time. Otherwise, poor lubrication will damage the engine.

Adding engine oil



After checking the oil level, if required, add engine oil following the steps below:

- Unscrew the oil filler cap counterclockwise.
- Add small amounts of engine oil repeatedly, and check the oil level after each filling.
- When the oil level is close to the maximum scale mark ②, indicating the engine oil is sufficient, stop adding oil, refit the oil filler cap and tighten it clockwise.

WARNING

- Be careful while adding the engine oil. Do not spill it. If the engine oil gets on skin, be sure to rinse the skin thoroughly.
- If too much oil is added, do not start the engine. In this case, please contact the GAC Motor authorized shop as soon as possible. Otherwise, the three-way catalytic converter may be damaged.
- After filling, be sure to tighten the oil filler cap to prevent the engine oil from splashing when the engine is being started, for fear of a fire.
- Since engine oil is toxic, it shall be stored in the original container and kept out of children's contact to avoid poisoning due to accidental ingestion.
- Do not add any lubricants to the engine oil. Otherwise, the engine will be damaged. Engine failure caused by adding lubricants is not covered by the warranty.

6. Operation and maintenance

6.4.3 Coolant

Function of coolant

Coolant has functions such as cooling, anti-freezing and anti-corrosion.

Specifications of coolant

When the vehicle leaves the factory, the cooling system has been filled with coolant, which can be used in the year-round climate except for extreme cold weather.

NOTE

- Coolant specifications: DF-6, -35°C coolant.
- Be sure to go to the GAC Motor authorized shop to change the coolant according to the period specified in the Warranty Manual.
- If the coolant discolors, the maintenance cycle shall be shortened and the coolant shall be changed at the GAC Motor authorized shop.

High engine coolant temperature indicator lamp

If the coolant temperature is too high, the indicator lamp on the instrument cluster comes on in red, and an alarm message is given to prompt the driver; at this time, the vehicle must be stopped in a safe place and the engine shut down. After the engine cools down, check the coolant level.

If the coolant level is normal but the indicator lamp is still on after the engine is started, do not continue to start the engine. In this case, contact the GAC Motor authorized shop timely for overhaul.

Inspecting the coolant level

Be sure to check the coolant level regularly. Park the vehicle on a level ground, apply the parking brake, and shut down the engine. After the engine cools down, open the engine hood and then check the coolant level.



WARNING

- **Be extremely careful while working in the engine compartment.**
- **The engine compartment is a high-risk area. Be sure to read and follow the relevant warning instructions carefully before opening the engine hood.**
- **If steam or coolant flows out from the engine compartment, do not open the engine hood, for fear of burns; wait till there is no steam or coolant overflowing and the engine cools down before opening the engine hood.**

6. Operation and maintenance

Engine coolant

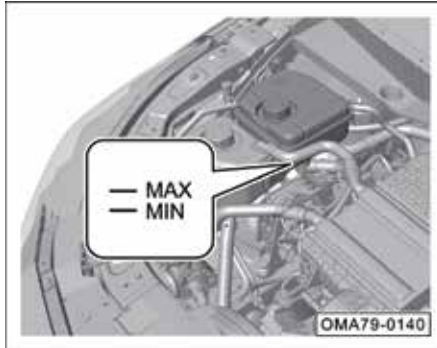

Check whether the coolant level in the expansion tank is between the maximum scale mark "MAX" and the minimum scale mark "MIN".

Intercooler coolant

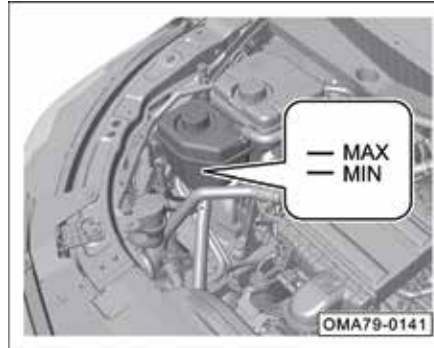

Check whether the coolant level in the intercooler coolant expansion tank is between the maximum scale mark "MAX" and the minimum scale mark "MIN".

CAUTION

When the coolant level is lower than the lower limit mark "MIN", coolant must be added. Insufficient coolant will affect the cooling effect and cause damage to the engine or intercooler.

Adding coolant

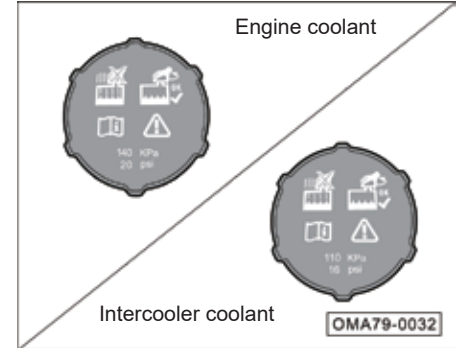

After checking the coolant level, if required, add coolant following the steps below:

- Wrap the expansion tank cap with a thick cloth and unscrew it counterclockwise.
- Add coolant to a level between the maximum scale mark "MAX" and the minimum scale mark "MIN".
- Turn the expansion tank cap clockwise to the locking point.

6. Operation and maintenance

CAUTION

- When the engine is not cooled, the cooling system is under high pressure. In this case, do not open the expansion tank cap, otherwise the emerging coolant will cause scald.
- Coolant can only be added after the engine or intercooler has cooled down. The coolant level after filling must not exceed the maximum scale mark "MAX". Otherwise, the coolant will overflow when the engine is started and the cooling system is under high pressure.
- Only fresh coolant is allowed to be added.

WARNING

- **It is forbidden to mix coolant that is not approved by our company in the original coolant.**
- **In case of emergency, if other coolant are used or pure water is added, go to the GAC Motor authorized shop in time to clean the cooling system and add new coolant.**
- **If the too much coolant is consumed or it is consumed too fast, there may be a leak in the cooling system. In this case, please go to the GAC Motor authorized shop for inspection in time.**
- **Coolant must be contained in the original container, and kept out of children's contact to avoid poisoning due to accidental ingestion.**

6.4.4 Windshield washer fluid and wiper blades

Adding windshield washer fluid

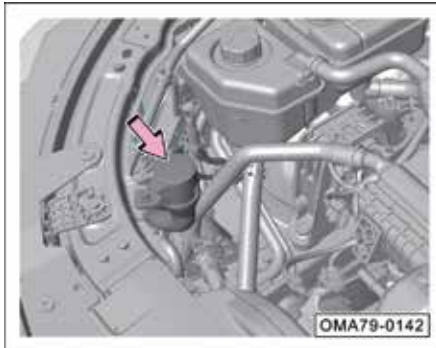

- If the level of the washer fluid is too low, the washer fluid shall be added in time.

CAUTION

- Do not use soapy water or other antifreeze as a substitute for washer fluid, as this may cause spots on the paint surface of the vehicle.
- Do not mix and use the windshield washer fluid with other cleaning liquids. Otherwise, the washer fluid will decompose and block the nozzle of the windshield washer.

WARNING

- **Be extremely careful while working in the engine compartment. Before operation, be sure to carefully read and follow the relevant warning instructions.**
- **Do not misuse coolant or any other additives as windshield washer fluid. Otherwise, oil stains will be left on the windshield during cleaning of the windshield, which will affect the visibility and easily cause accidents.**
- **It is forbidden to use windshield washer fluid with ethanol content exceeding 10%. In high temperature environment, this type of windshield washer fluid will have corrosive effect on lamps and lead to cracking of lamps. It is recommended to use methanol washing solution.**

6. Operation and maintenance

Replacing front windshield wiper blades



- Set the START/STOP button to the "ON" gear and then to the "OFF" gear.
- Move the wiper combination switch to the "MIST" position within 10s. The wiper arm will stop after running for half a turn.

i NOTE

When the wiper switch is in the "OFF" position, click the "Wiper Maintenance Mode" soft key through the "Settings → Body Accessories → Other Accessories" in the AV system, and the wiper arm will run for half a turn and then stop. Click the right soft key again to reset the wiper arm.

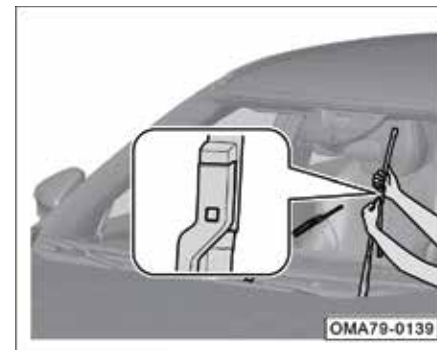

- Pull up the wiper arm, press the lock button - arrow -, and remove the wiper blade.
- Slowly release the wiper arm.
- Install the new wiper blade into the wiper arm in reverse steps. It is installed in place when a "click" is heard.
- Gently put the wiper arm back into the windshield.
- When the START/STOP button is set to "ON" position, the wiper arm will automatically return.

CAUTION

- Only after the wiper arm is adjusted to wiper maintenance mode can it be pulled up.
- Do not open the engine hood when the wiper is pulled up, as this may damage the engine hood and wiper arms.
- When lifting the wiper arm, please hold the wiper arm with hands, rather than grasp the soft wiper blade.
- New wiper blades with the same length and specifications as the previous ones must be used.
- Be careful while lowering the wiper arm to prevent it from falling and hitting the windshield instantly.
- The status of the wiper blades must be checked regularly, and the wiper blades must be replaced as specified. Damaged wiper blades must be replaced in time.
- Excessively worn or dirty wiper blades are very easy to scratch the windshield and will affect the field of vision when used, reducing driving safety.

6.4.5 Brake fluid

Function of brake fluid

Brake fluid is used to transmit power in the hydraulic brake system of the vehicle.

The brake fluid is water-absorbent, so it can continuously absorb moisture in the surrounding air during use. If the brake fluid stays in the system for too long and absorbs too much moisture, air resistance will generate in the system pipeline during braking, reducing the braking effect and impairing driving safety; it may even cause the complete failure of the brake system, resulting in accidents. Therefore, be sure to go to the GAC Motor authorized shop to check the brake fluid level or change the brake fluid according to the period specified in the Warranty Manual.

NOTE

Brake fluid specifications: DOT4.

WARNING

- **The use of waste brake fluid or brake fluid that does not apply to this vehicle will greatly reduce the braking effect and even lead to brake system failure! The company does not assume any responsibility (including quality guarantee) for vehicle failures and damage caused thereby.**
- **Brake fluid in use must meet the criteria and be fresh.**

Brake system indicator lamp

If the red indicator lamp  comes on and the instrument cluster displays the message "Please replenish brake fluid" while the vehicle is running, it is necessary to immediately stop at a safe place and check if the brake fluid level is normal.

6. Operation and maintenance

Inspecting brake fluid level

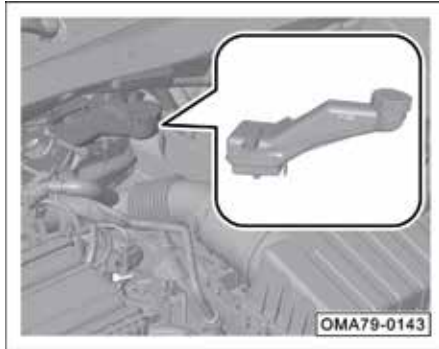

After the engine cools down, check whether the brake fluid level is between the maximum scale mark "MAX" and the minimum scale mark "MIN".

During vehicle use, the brake fluid level will slightly drop due to the worn brake linings and automatic adjustment.

If the brake fluid level drops significantly in a short period of time or drops below "MIN", it indicates that the brake system may leak.

i NOTE

- Be sure to read and follow the relevant warning instructions carefully before opening the engine hood.
- After check of the brake fluid level, if the fluid level is below "MIN", brake fluid must be added.
- If the brake system warning lamp does not go out or comes on again after the brake fluid is added, there may be a leak in the brake system, causing the brake fluid level to drop quickly, or the brake system malfunctions. In this case, do not continue to drive and contact the GAC Motor authorized shop in time for inspection.

Adding brake fluid

In order to ensure the normal operation of the brake system, the added brake fluid shall meet the specifications:

- Open the brake fluid reservoir cap counterclockwise.
- Add fresh brake fluid to the maximum scale mark "MAX" and stop adding.
- Tighten the brake fluid reservoir cap clockwise.

CAUTION





- The brake fluid will corrode the paint surface of the vehicle body. Brake fluid splashed on the paint surface shall be wiped off in time.
- Using waste brake fluid or using brake fluid not applicable to the vehicle will remarkably reduce the braking effect due to incompatibility and even cause the brake system to fail.

WARNING

- **Brake fluid is toxic. It must be contained in the original sealed container, placed in a safe place, and kept out of children's contact to avoid poisoning due to accidental ingestion.**
- **Brake fluid must be stored in accordance with environmental protection laws.**

6.4.6 Battery

Warning symbols and instructions for battery operation

	Goggles must be worn during operation!
	The battery electrolyte is highly corrosive. Protective gloves and goggles must be worn during operation!
	Open flames, sparks, uncovered lamps and smoking are prohibited in the workplace!
	Very explosive gas mixture is generated when the battery is being charged!
	Children must stay away from electrolytes and vehicle batteries!

In case of unfamiliarity with the operation process or no special tools, never carry out any operations on the electrical system of the vehicle, and contact the GAC Motor authorized shop.

Charging system warning lamp

The warning lamp is used to indicate alternator failure.

When the START/STOP button is set to "ON" position and the engine is not started, the  warning lamp lights up, and the warning lamp shall go out after the engine is started.

When the vehicle is running, if the warning lamp comes on, it indicates that the alternator is no longer charging the battery. In this case, please go to the GAC Motor authorized shop for inspection in time.

6. Operation and maintenance

Inspecting the battery

The battery must be checked according to the period specified in the Warranty Manual.

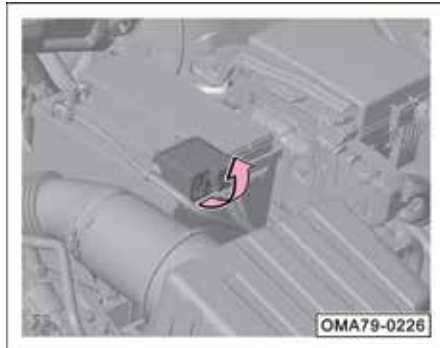

- Flip up the cover of the battery positive terminal.
- Check the connection of the battery connector and the cable for corrosion or looseness; check the appearance of the battery for cracks, swelling, etc. If the phenomena above are found, please go to the GAC Motor authorized shop for inspection in time.
- If the vehicle is not in use for a long period of time, check the battery condition frequently.

i NOTE

- If the battery power is insufficient or the battery is damaged, making it difficult to start the vehicle, please contact the GAC Motor authorized shop to charge or replace the battery in time.
- If it is required to replace the battery, please go to the GAC Motor authorized shop for replacement; if a wrong type of battery is used, the vehicle may not run due to incompatibility or the electrical system may fail.

Instructions for using the battery

After the engine is turned off, the battery will quickly discharge when an electrical consumer on the vehicle is being used:

1. Do not use an electrical consumer on the vehicle for a long time after the engine is turned off.
2. While leaving the vehicle, make sure that the doors are closed and all electrical consumers (e.g., lamps) are turned off.

👁 CAUTION

- If the engine can not be started due to depleted battery, please try emergency start. If the engine still can not be started, please contact the GAC Motor authorized shop for overhaul.
- To avoid damage to the electrical system of the vehicle, never connect power generation equipment such as solar panels or vehicle battery chargers to a 12V power outlet.
- The battery contains toxic substances such as sulfuric acid and lead, so it must be disposed of properly and must not be treated as ordinary household waste.

6.5 A/C filter

Inspecting and cleaning the A/C filter

Check or clean the A/C filter regularly according to the provisions in the Warranty Manual. If the vehicle is running in a dusty environment and the A/C filter is too dirty, it is recommended to replace the A/C filter earlier.

The A/C filter is located inside the front passenger's glove box. When removing the A/C filter, it is more complicated to disassemble the parts. In order to avoid unnecessary component damage, it is recommended to check and clean or replace the A/C filter at the GAC Motor authorized shop.

6.6 Replacing bulb

Instructions for replacing bulbs

When replacing bulbs, be careful not to touch the bulb glass with fingers. Otherwise, the heat of the bulb will evaporate the grease on the bulb from fingerprints and condense it on the bulb glass, reducing the illuminance of the lamp.

After replacing bulbs, be sure to check the operating status of lamps, and go to the GAC Motor authorized shop to check the beam status in time.

NOTE

- All vehicle lamps are halogen lamps or LED. If the LED lamps are damaged, please go to the GAC Motor authorized shop for replacement in a timely manner.
- The removing and installing methods of the left and right bulbs are basically the same. Here only the removing and installing methods of halogen bulbs on one side are described.

CAUTION

The damaged bulb must be replaced with a new bulb of the same specification. The bulb specification of this vehicle. => See [page 252](#)

WARNING

If you are unfamiliar with the operation process, safe operation specifications and tool operation methods, do not replace bulbs yourself.

- **Turn off all lamps before replacing bulbs, and wait for bulbs till they are cool before replacement.**
- **Pay attention to the sharp parts on the combination lamp housing in the engine compartment during operation, and be careful not to scratch hands while replacing bulbs.**

6. Operation and maintenance

Preparation for replacing bulbs

If it is found that any bulb is damaged, replace the bulb as soon as possible. Before replacement, make the following preparations:

1. Turn off all lamps.
2. Set the ignition switch to the "OFF" position.
3. Check whether the related fuse is blown. When the fuse is in good conditions, perform bulb inspection and replacement.

Removing rear combination lamp



1. Open the liftgate.
2. Pry off the small trim panel ①.

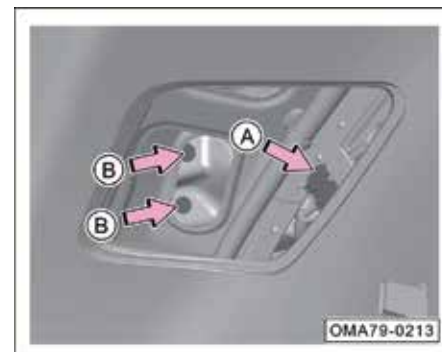

3. Disconnect the connector (arrow A) of the rear combination lamp.
4. Screw out the fixing nut (arrow B) of the rear combination lamp.



5. Take out the rear combination lamp ①.
6. Install the rear combination lamp in the reverse order after removing it.

Replacing rear turn signal lamp bulb

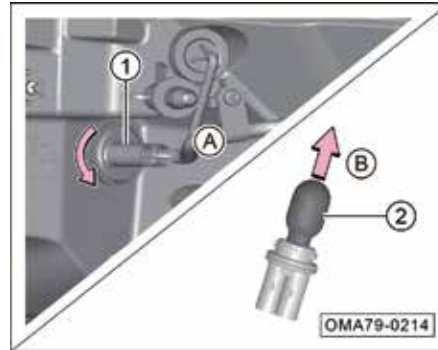

1. Remove the rear combination lamp. => See page 234
2. Take out the turn signal lamp bulb and holder ① as indicated by arrow A.
3. Take out the rear turn signal lamp bulb ② in the direction of arrow B.
4. Replace the original bulb with a new rear turn signal lamp bulb in the reverse order.

Replacing license plate lamp

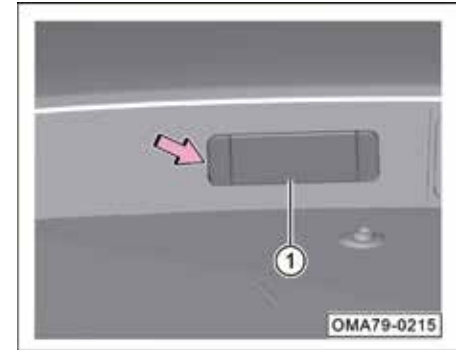

1. Pry out the license plate lamp assembly ① as arrowed.

6. Operation and maintenance

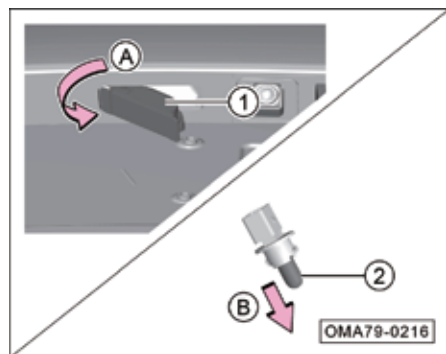

2. Disconnect the harness connector and rotate it as arrowed A to remove the license plate bulb and socket ①.
3. Take out the bulb ② as indicated by arrow B.
4. Replace the original bulb with a new license plate lamp bulb in the reverse order.

Replacing vanity mirror lamp bulb*

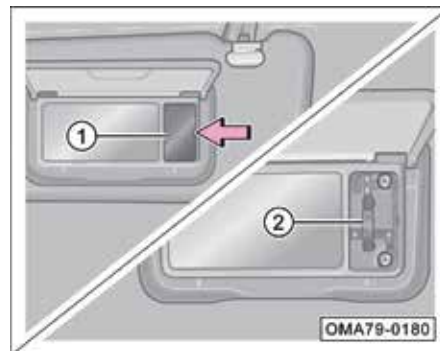

1. Carefully pry out the vanity mirror lampshade along the arrow position ①.
2. Take out the vanity mirror lamp bulb ②.
3. Replace the original bulb with a new vanity mirror lamp bulb in the reverse order.

6.7 Wheel

⚠ WARNING

Within the first 500 km, the road adhesion of new tires is unlikely to reach the best condition. Therefore, the vehicle shall be drove carefully at a moderate speed to prevent accidents.

- Inadequate road adhesion of tires not subject to running-in period or excessively worn can directly affect the braking effect.
- If abnormal vibration or deviation of the vehicle is found during driving, stop the vehicle immediately and check whether the tire is damaged.
- If it is found that the tires are unevenly and excessively worn, please go to the GAC Motor authorized shop for inspection as soon as possible.

WARNING

If tires burst or leak when the vehicle is running, it is very easy to cause serious traffic accidents.

- Never use damaged tires and wheels, or use tires of which the treads have been worn to the wear indicators. Otherwise, it is very easy to cause an accident, because such tires may burst during driving, causing traffic accidents and injury. Such tires and wheels shall be replaced in time.
- The tire pressure must meet the regulations. Otherwise, it may cause an accident. If the tire pressure is insufficient, the continuous high-speed running of the vehicle will cause the tire to deflect, and the tire is extremely easy to overheat, which may cause tread separation or tire burst.
- Do not expose tires to chemicals, oil, grease, fuel and brake fluid.

WARNING

- Never use old wheels and tires of unknown origin under any circumstances. Although such wheels and tires do not have visible damage, they may have been damaged. During driving, they may cause the vehicle to lose control and lead to traffic accidents.
- It is not recommended to use recycled tires. For such tires, the carcass may degrade as the service time passes, and the durability may also be restrained, impairing the driving safety.

Precautions for wheel failure

- When driving over curbs or similar obstacles, keep a slow speed in the vertical direction of the obstacles as much as possible.
- Keep tires off grease, oil or fuel.
- Regularly check the tire damage status (e.g. cuts, wear, shedding, deformation or bulge).
- Regularly remove debris embedded in the grooves of the tire pattern.

Instructions for storing tires

- Before removing the tire, make a mark on the tire to indicate the rotation direction of the tire. Refit the tire according to the mark to ensure the rotation direction and the dynamic balance of the wheel are unchanged.
- Store the removed wheels or tires in a cool, dry place, and preferably in a dark place.
- The tire mounted on the rim must not be stored upright.

6. Operation and maintenance

New tires and wheels

- Select the new tire and wheel carefully, and make sure that the dimensions, load range, rated speed and structure type of new tire are the same as those of original one.
- Replace at least two tires on the same axle at the same time, rather than only one tire individually.
- Do not use tires of different dimensions or types, and do not mix summer tires, all-season tires and winter tires in use.
- After each wheel installation, check whether the wheel bolts are tightened to specified torque (125±10N•m).

Non-full-size spare tires

Spare tires and standard tires are different in aspects such as structure, pattern, speed rating and load index, and cannot be exchanged.

After emergency use of the spare tire, it is necessary to drive safely to the GAC Motor authorized shop or the wheel repair shop as soon as possible to replace it with a full-size spare tire, so as to avoid the hidden safety hazards of long-term use of the spare tire.

WARNING

- **Spare tires can only be used temporarily for emergency, and the maximum driving speed shall not exceed 80 km/h.**
- **The storage and service life of spare tires is 6 years. It is prohibited to use them beyond the time limit.**

Summer tires

Summer is a rainy season. The tire tread depth directly affects the driving safety in rainy days. In summer, when the tire tread depth is less than 3mm, there is a high risk of water slippage.

Winter tires

Winter tires still have good grip performance when roads are covered with snow and ice. The specially designed rubber tread makes the tires less affected by low temperature environment and excellent braking ability, ensuring driving safety.

- Use winter tires on all the four wheels.
- Use only radial winter tires of the same dimensions, load range and rated speed as original ones on this vehicle.

6. Operation and maintenance

- Please note that the tread of winter tires shall have patterns deep enough (tread depth not less than 4mm; otherwise, the applicability in winter will be limited).
- After installation of tires, check the tire inflation pressure.

⚠ WARNING

- Winter and summer tires are designed according to the typical lane driving conditions under the corresponding seasonal conditions. It is recommended to use winter tires in winter. At low temperatures, the adaptability of summer tires is significantly poorer, thereby losing road adhesion and braking ability.
- If summer tires are used in severe cold conditions, cracks may appear on the tires, thereby completely damaging the tires, and causing excessive tire noise and loss of balance.

⚠ WARNING

- After using winter tires, there may be decreased driving traction on dry roads, increased road noise and shortened tread life. Please pay attention to the performance change of the vehicle in terms of maneuvering and braking after the winter tires are used.
- Please note that the maximum speed for winter tires is relatively low. Do not exceed the allowable maximum speed for the tires.
- Please note that please replace the winter tires with summer tires in time in order to ensure driving safety and performance when driving in the environment at the atmospheric temperature rising above 7°C.
- When driving with winter tires, if a spare tire is installed, unstable steering characteristics may occur due to different tires, weakening driving stability. In this case, driving styles need to be adjusted and driving shall be performed carefully.

Inspecting tire pressure

	100kPa=1bar		kPa	
225/55 R18 98V	230	230	230	230
235/45 R19 99Y	230	230	230	230
T125/90 R17 99M	420			

OMA79-7015

The standard pressure data label of the original tire of this vehicle is attached to the right B pillar of the vehicle.

- Unscrew the valve cap (if the valve cap is missing, a new one shall be provided in time).
- A high-quality tire pressure gauge is required to check the tire pressure. It is impossible to determine whether the tire pressure is appropriate only by visual inspection.
- Attach the tire pressure gauge to the valve.
- For inspection of tire pressure, the tire must be in a cold state. When the temperature increases, the tire pressure can be slightly higher than the specified value, and it is not necessary to reduce the tire pressure.

6. Operation and maintenance

- Balance the weight of occupants and luggage, avoid slopes and adjust tire pressure according to vehicle load.
- Check the tire pressure of the spare wheel or emergency spare wheel at the same time.
- Install and tighten the valve cap.

i NOTE

- The current wheel tire pressure can be viewed through the instrument cluster display.
- Be sure to reinstall the valve cap on the valve core. The valve cap can prevent dust and moisture from entering the tire.

⚠ WARNING

- **Abnormal tire pressure may cause tire burst, resulting in a traffic accident, injury or even death.**
- **Check the tire pressure at least once a month or before long-distance driving. The tire pressure must meet the specified requirements to prevent accidents.**
- **Insufficient tire pressure will exacerbate tire deflection, and tires are extremely prone to overheating, which may lead to tread separation and tire burst.**
- **Abnormal tire pressure, too low or too high, will cause early wear of tires and reduce the maneuvering stability of the vehicle.**

Service life of tires

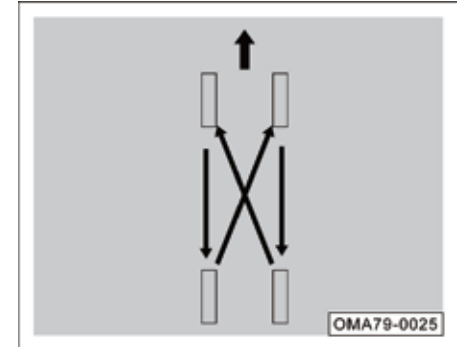

Service life of tires depends on tire pressure, driving style and tire assembly conditions.

If the front tires are worn more serious than the rear tires, it is recommended to perform tire rotation for the front and rear wheels as shown, so as to make the service life of all tires about the same.

Tread wear indicator

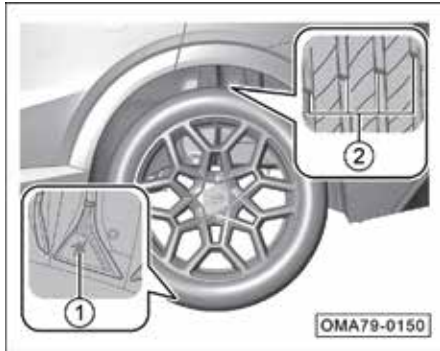

The mark ① is used to indicate the wear condition of the tire outer circle pattern. If the tire outer circle pattern wears to the condition as shown, the tire can no longer be used safely and must be replaced immediately.

“The height of tread wear indicator” ② is 1.6 mm. If the tread pattern is worn to the indicator surface, this tire can no longer be used safely and must be replaced immediately.

Wheel balance

The wheels of the new vehicle are already balanced. Due to various reasons, the wheels may go unbalanced during operation, which can be manifested by the vibration of the steering mechanism.

Because unbalanced wheels can cause excessive wear on the steering system, wheel suspension mechanism and tires, the wheels shall be rebalanced.

In addition, wheels must be rebalanced after installation of a new tire or tire repair for any wheel.

Wheel misalignment

Wheel misalignment will cause uneven and excessive wear of the tires, affecting driving safety. If uneven and excessive wear of the tires is found, please go to the GAC Motor authorized shop to check the wheel alignment in time.

6.8 Tire chain

In winter, driving in harsh environments such as snowy or icy roads can increase the degree of tire wear or cause other failures. To reduce failures in winter, the following opinions must be followed:

- When driving in deep snow, it is necessary to install tire chains on the tires. In this case, be sure to choose an equivalent product whose size and type meet the specifications of the tires on the vehicle. Failure to do this will adversely affect the performance and safety of the vehicle. Moreover, operations such as full-load driving, speeding, emergency acceleration, emergency braking, and emergency turning are potentially dangerous.
- During deceleration, make full use of the engine braking function. Emergency braking on snowy or icy roads will cause the vehicle to drift and slip. Keep a proper safe distance from the lead vehicle, and step on the brake pedal slightly. Note that the tire chain installed on the tire can provide a certain friction force, but it cannot prevent sideslip.

6. Operation and maintenance

NOTE

Various countries and regions have different regulations on tire chains. Before assembling tire chains, please refer to the laws and regulations of the corresponding country and region. Do not install tire chains without understanding the laws and regulations of the corresponding country and region that may restrict the use of tire chains.

CAUTION

- Install tire chains on all tires to ensure balanced driving in all weather. It shall be borne in mind that after installation of tire chains, the vehicle may be underpower. Even if the road surface is in good condition, drive carefully. While driving, neither exceed the specified speed limit of tire chains nor exceed 50 km/h, whichever is lower.

CAUTION

- If tire chains are installed on the tires, the size and type of tire chains shall be consistent with those of the standard tires of the vehicle. Otherwise, the driving safety and maneuvering of the vehicle will be adversely affected.
- Tire chains must be installed in pairs on the front wheels rather than on the rear wheels.
- Do not install the tire chain on the emergency spare tire. If a spare tire is installed on the front wheel and a tire chain is required, be sure to exchange the positions of the spare tire and the rear tire.
- Do not use tire chains on dry ground. After driving to snow-free roads, remove tire chains.
- After installing the tire chains as closely as possible to the front tires, drive 0.5~1.0km, and then tighten the tire chains again.

7.1 VIN

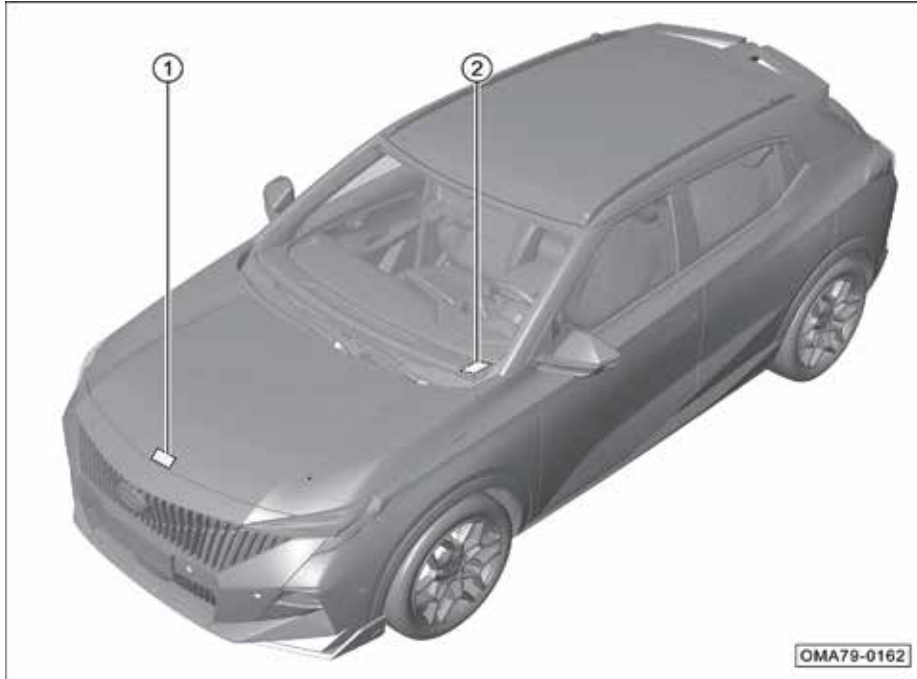

The locations of the vehicle identification number (VIN) is shown in the figure:

- ① VIN: Engine compartment hood.
- ② VIN: Left side of instrument panel.

i NOTE

The position indication and quantity of vehicle identification number (VIN) are not complete. Please refer to the actual vehicle.

7. Technical Data

OBD DLC



The OBD DLC ① for reading the electronic VIN is located at the lower left of the instrument panel. Data such as the electronic VIN and vehicle status information can be read through a special diagnostic scan tool.

i NOTE

If you need to buy a diagnostic scan tool, please go to the GAC Motor authorized shop for consultation and purchase.

Vehicle nameplate



The vehicle nameplate label is located at the driver side B-pillar.

i NOTE

The illustration is for reference only, and the actual content of the nameplate shall be subject to the actual vehicle.

Engine model and factory number

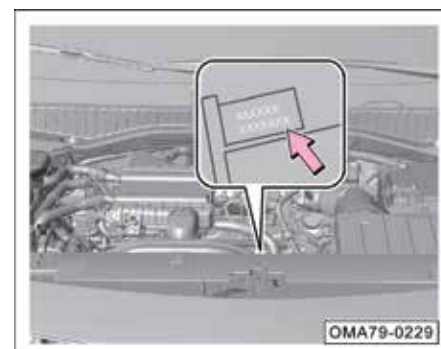

Engine model and serial number as arrowed is located on the engine block (above the starter).

7.2 Dimensions & parameters of vehicle

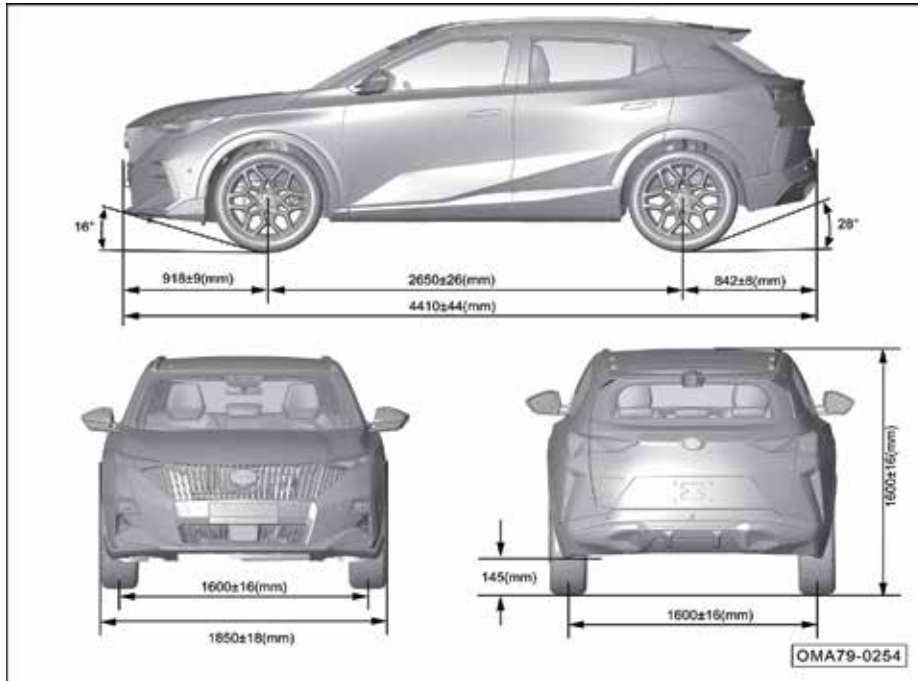

Type 1

Dimensions

Item		Parameters	
		Unit	Unit
Overall length		4410±44	mm
Overall width		1850±18	mm
Overall height		1600±16	mm
Wheelbase		2650±26	mm
Wheel track	Front wheel	1600±16	mm
	Rear wheel	1600±16	
Front overhang		918±9	mm
Rear overhang		842±8	mm
Minimum ground clearance (full load)		145	mm
Approach angle (full load)		16	.
Departure angle (full load)		28	.

Note: External rearview mirrors (one on the right and one on the left) near the junction of the lower end of the A pillar and the front door and the antenna above the rear of the roof are not included in the overall width.

7. Technical Data

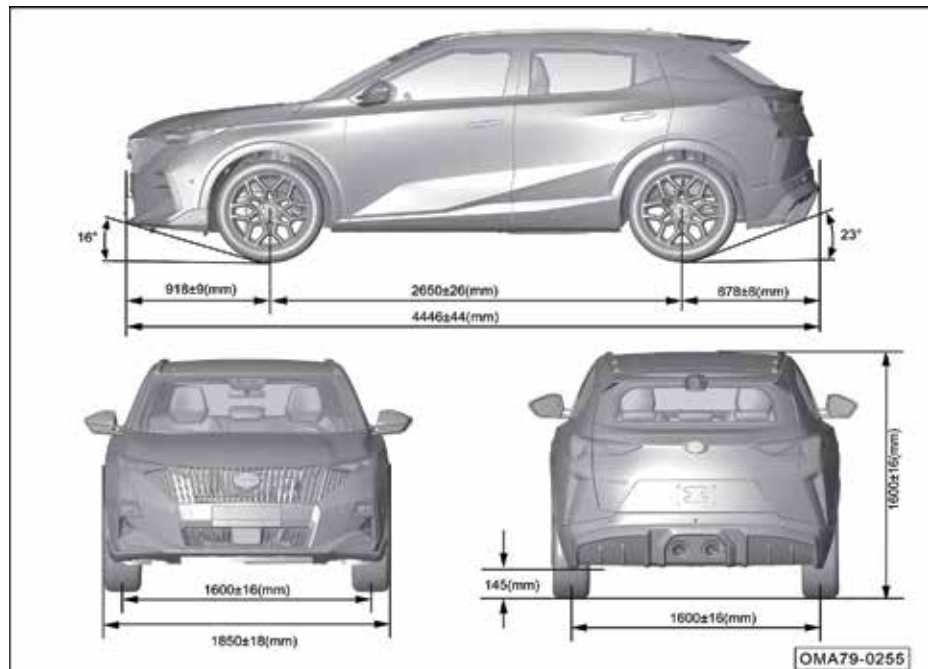

Type 2

Dimensions

Item		Parameters	
		Unit	Unit
Overall length		4446±44	mm
Overall width		1850±18	mm
Overall height		1600±16	mm
Wheelbase		2650±26	mm
Wheel track	Front wheel	1600±16	mm
	Rear wheel	1600±16	
Front overhang		918±9	mm
Rear overhang		878±8	mm
Minimum ground clearance (full load)		145	mm
Approach angle (full load)		16	.
Departure angle (full load)		23	.

Note: External rearview mirrors (one on the right and one on the left) near the junction of the lower end of the A pillar and the front door and the antenna above the rear of the roof are not included in the overall width.

7.3 Vehicle mass & parameters of engine and fluids

Mass

Model	Kerb mass of vehicle (kg)			Gross vehicle weight rating (kg)		
	Kerb mass (kg)	Front axle load	Rear axle load	Gross vehicle weight rating	Front axle load	Rear axle load
GAC7151HCW6A	1370±41	842±25	528±15	1795	985	810
	1415±42	855±25	560±16			

Comprehensive parameters

Item	Corresponding model parameters	Unit
	GAC7151HCW6A	
STT	Non-STT	/
Seating capacity	5	Person
Minimum turning diameter	11.3	m
Maximum gradeability	40	%
Maximum speed	190	km/h
WLTC comprehensive fuel consumption	6.18	L/100km

7. Technical Data

Parameters of engine

Model	4A15J2
Layout	Front mounted, transverse layout
Type	Gasoline engine, spark-ignition, in-line, 4-cylinder, 4-stroke, turbocharged and intercooled, GDI, DOHC, exhaust gas turbocharging
Number of cylinders	4
Ignition order	1-3-4-2
Cylinder diameter (mm)	74
Stroke (mm)	87
Displacement(mL)	1497
Compression ratio	(11.5±0.3):1
Rated power/Speed (kW/(r/min))	130/5500
Maximum net power/Speed (kW/(r/min))	125/5500
Maximum torque/Speed (N•m/(r/min))	270/1400~4500
Maximum net torque/Speed (N•m/(r/min))	250/1400~4500
Emission level	China VI

Specifications and capacity of fuel/oil/fluid

Item	Specification	Capacity	
Fuel ¹⁾	92# and above premium unleaded gasoline	Total	47L
Engine coolant ²⁾	DF-6, -35°C coolant	Total	8.3L
Engine oil:	Oil grade: API SN/ILSAC GF-5 Oil viscosity: SAE 0W-20	Total ³⁾	4.5L
		Replace ⁴⁾	4.2L
WDCT fluid	Shell Spirax S5 DCT12 plus	Total	6.9L
		Change	5L
Intercooler coolant	DF-6, -35°C coolant	Total	3.2L
Brake fluid	DOT4	Total	0.7L
Windshield washer fluid	Methanol typeQ35	Total	2.5L
A/C refrigerant	R134a	Total	510g

Notes: 1) Long-term use of fuels with a sulfur content higher than the standard value may result in excessive emissions. Please pay attention and use fuels that comply with local standards for vehicles.

2) Including the coolant in the reservoir and the residual coolant in the engine.

3) Capacity of the overhauled engine assembly.

4) Including the replacement of oil filter.

7. Technical Data

7.4 Specifications of transmission, chassis and vehicle lamps

Transmission parameters

Model	7WF25G
Type	WDCT
Drive	2WD
Final ratio	4.389(5124Rgear)
	2.724(736gear)
1st gear	3.846
2nd gear	2.308
3rd gear	2.500
4th gear	1.140
5th gear	0.911
6th gear	1.180
7th gear	0.946
Reverse gear	3.491

Suspension

Type	Front suspension	Rear suspension
	McPherson, independent	Twist-beam dependent suspension

Wheels

Specifications of rim		7J×18*, 8J×19*	
Tire specification		225/55R18*, 235/45R19*	
Tire pressure	-	Front wheel	Rear wheel
	Half load	230 kPa	230 kPa
	Full load	230 kPa	230 kPa
Specifications of spare tire		T125/90R17	
Pressure of spare tire		420 kPa	

Steering gear

Type	Rack and pinion
Power steering type	Electric power steering

Brake

Type	X type dual circuit, hydraulic braking, vacuum assisted
Front wheel	Disc brake
Rear wheel	Disc brake
Parking brake	Electric park brake (EPB)

Dynamic balance of wheels

Designation		Residue dynamic unbalance
Front wheel	Inner side	≤8g
	Outer side	≤8g
Rear wheel	Inner side	≤8g
	Outer side	≤8g

Free travel of brake pedal

Designation	Parameters
Travel	106.4 mm
Free travel	5.6 mm

Technical parameters of brake linings

Designation	Parameters
Wear limit of front wheel brake lining (excluding the backplate of brake lining)	2 mm
Wear limit of rear wheel brake lining (excluding the backplate of brake lining)	2 mm

Wheel alignment parameters

Designation		Parameters
Front wheel	Individual toe-in	5'±5'
	Wheel camber	-15'±45'
	Kingpin caster angle	6°23'±45'
	Kingpin inclination angle	13°22'
Rear wheel	Total toe-in	4'±24'
	Wheel camber	-1°16'±30'
	Thrust angle	0'±24'

7. Technical Data

Lamps

Lamps	Model	Power
High beam	LED	/
Low beam	LED	/
Daytime running lamp*	LED	/
Front turn signal lamp*	LED	/
Front position lamp	LED	/
Rear fog lamp	LED	/
Side turn signal lamp	LED	/
Brake lamp	LED	/
Rear position lamp	LED	/
High-mounted stop lamp	LED	/
Rear turn signal lamp	WY16W	16W
Reverse lamp	LED	/

Lamps	Model	Power
License plate lamp	W5W	5W
Front dome lamp	LED	/
2nd-row dome lamp*	LED	/
Vanity mirror lamp*	14V1CP	1.4W
Ambient light *	LED	/
Trunk lamp*	LED	/

All vehicle lamps are LED lamps. For replacement, => See page 233.

7.5 Fuse specification

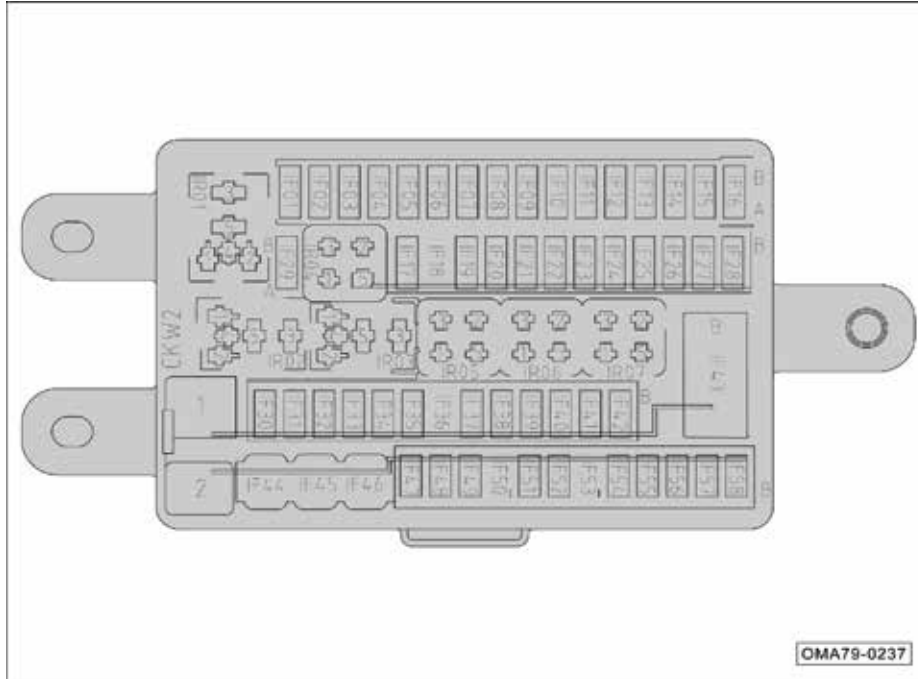

Fuses in instrument panel PDU

The fuses may slightly vary from vehicle to vehicle. In this regard, the actual vehicle shall prevail.

7. Technical Data

No.	Rated value	Feature/component
IF01	20A	Front 12 V power supply
IF02	7.5A	Integrated BCM
IF03	7.5A	ACU/GVM
IF04	7.5A	Rear USB interface*/Smart phone WCM*
IF05	20A	USB_TYPE_C port
IF06	—	—
IF07	7.5A	GWM/T-BOX ECU*
IF08	20A	ACU*
IF09	7.5A	HCP/GVM/A/C ECU/Smart phone wireless charging module
IF10	20A	Left front seat connector (HVSM)*
IF11	7.5A	DMS ECU*/Rain and light sensor*
IF12	—	—
IF13	7.5A	Integrated BCM/Defogger relay(ER07)
IF14	—	—
IF15	—	—
IF16	—	—
IF17	10A	SRS ECU
IF18	7.5A	Wet dual clutch transmission ECU/ECM
IF19	7.5A	GWM//GVM/T-BOX ECU*
IF20	—	—

No.	Rated value	Feature/component
IF21	7.5A	ESP and EPB ECU/EPB ECU/Brake switch
IF22	7.5A	GSM/EPS ECU
IF23	7.5A	A/C ECU/HCP/Panoramic sunroof ECU*/Left front seat connector (HVSM)*/*Front ceiling lamp assembly
IF24	7.5A	EPB control unit
IF25	7.5A	Left instrument panel switch group/Left front combination lamp/Right front combination lamp
IF26	7.5A	RPA ECU*/FAPA ECU*/AVM RPA ECU*/ACU/ Instrument cluster
IF27	—	—
IF28	—	—
IF29	—	—
IF30	—	—
IF31	20A	Integrated BCM (door lock power supply)
IF32	20A	Integrated BCM
IF33	20A	Integrated BCM (door lock power supply & windshield washer motor power supply)*
IF34	—	—
IF35	7.5A	GVM/RF receiver module
IF36	15A	Integrated BCM (turn signal lamp power supply)
IF37	7.5A	GSM
IF38	—	—

7. Technical Data

No.	Rated value	Feature/component
IF39	7.5A	Instrument cluster/ AV system display
IF40	—	—
IF41	7.5A	OBD DLC
IF42	—	—
IF43	Dark current switch	A/C ECU/ mobile phone WCM*/RLS*/ A/C control panel/ left front seat connector (HVSM)*/ACU
IF44	30A	Power liftgate module*
IF45	30A	Right front door control module
IF46	30A	Left front door control module
IF47	20A	Integrated BCM (main light power supply 2)*
IF48	20A	Integrated BCM (main light power supply 1)*
IF49	10A	Left front seat connector (HVSM)*
IF50	15A	IG2 relay (IR07)
IF51	20A	Left front seat connector (seat adjusting switch)*
IF52	—	—
IF53	15A	Integrated BCM (windshield washer motor power supply)
IF54	—	—
IF55	20A	Panoramic sunroof ECU*
IF56	—	—
IF57	7.5A	FAPA ECU*/AVM ECU*
IF58	7.5A	Power liftgate module*

No.	Rated value	Feature/component
IR01	—	ACC relay
IR02	—	Lock-up relay 1
IR03	—	Lock-up relay 2
IR04	—	IG1 relay
IR05	—	—
IR06	—	—
IR07	—	IG2 relay

7. Technical Data

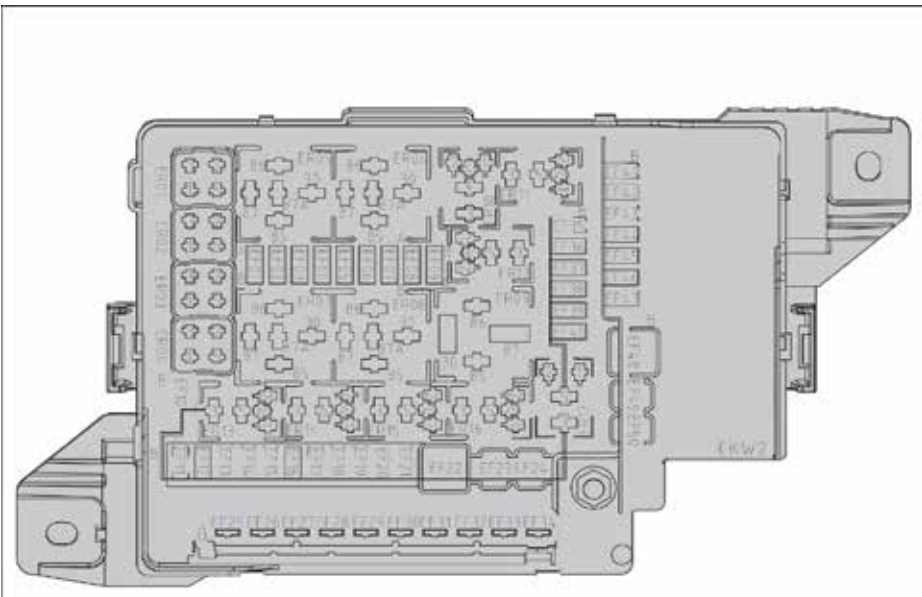

Fuses in engine compartment PDU

The fuses may slightly vary from vehicle to vehicle. In this regard, the actual vehicle shall prevail.

7. Technical Data

No.	Rated value	Feature/component
EF01	—	—
EF02	—	—
EF03	—	—
EF04	7.5A	ECM
EF05	—	—
EF06	—	—
EF07	7.5A	Exterior rearview mirror heater*
EF08	—	—
EF09	—	—
EF10	30A	Wet dual clutch transmission ECU
EF11	30A	Wet dual clutch transmission ECU
EF12	15A	Horn relay(ER03)/horn
EF13	30A	Wet dual clutch transmission ECU
EF14	7.5A	MRR module*/LDW module*
EF15	—	—
EF16	20A	Fuel pump/ fuel pump relay (ER14)
EF17	20A	Wiper/wiper speed control relay (ER11)/wiper relay (ER12)
EF18	7.5A	Brake switch
EF19	7.5A	Main relay (ER17)/ECU
EF20	—	—
EF21	20A	Right front combination lamp

No.	Rated value	Feature/component
EF22	60A	To instrument panel PDU
EF23	40A	ESPI
EF24	30A	EPB control unit
EF25	30A	Starter/ starter relay (ER15)
EF26	40A	ACC power supply
EF27	40A	To HVAC assembly (blower)/ blower relay (ER05)
EF28	40A	Rear windshield defogger heater +/-exterior rearview mirror heater*/ defogger relay (ER07)
EF29	—	—
EF30	50A	Low speed cooling fan relay (ER06)
EF31	50A	GVM/T-BOX ECU*
EF32	60A	To instrument panel PDU
EF33	60A	High speed cooling fan relay(ER09)
EF34	80A	EPS ECU
EF35	10A	Fuel pump relay (ER14)/Water pump relay(ER01)/ High speed cooling fan relay (ER09)/Low speed cooling fan relay (ER06)
EF36	15A	Ignition coil 1/ignition coil 2/ignition coil 3/ignition coil 4
EF37	15A	ECM/Starter relay 1(ER15)/Starter relay 2(ER16)
EF38	10A	Upstream oxygen sensor/Downstream oxygen sensor/ Compressor relay (ER04)

7. Technical Data

No.	Rated value	Feature/component
EF39	10A	PCV heater relay (ER01)/PCV heater/Canister vent valve/Electronic inlet air recirculation valve/Canister solenoid valve/Oil pump solenoid valve/Oil control valve (intake end)/Oil control valve (exhaust end)
EF40	10A	Left EAV valve
EF41	30A	IG1 On
EF42	10A	Water pump relay (ER01)
EF43	—	—
EF44	—	—
EF45	7.5A	Front blower relay (ER05)/Compressor relay (ER04)
EF46	—	—
EF47	20A	Left front combination lamp
EF48	40A	ESPI
EF49	—	—
EF50	30A	EPB control unit
ER01	—	Water pump relay
ER02	—	—
ER03	—	Horn relay
ER04	—	Compressor relay
ER05	—	Front blower relay
ER06	—	Low speed fan relay
ER07	—	Defogger relay

No.	Rated value	Feature/component
ER08	—	—
ER09	—	High speed fan relay
ER10	—	PCV heater relay
ER11	—	Wiper speed control relay
ER12	—	Wiper relay
ER13	—	—
ER14	—	Fuel pump relay
ER15	—	Starter relay 1
ER16	—	Starter relay 2
ER17	—	Main relay

8.1 Driver's tools and spare tire

Driver's tools

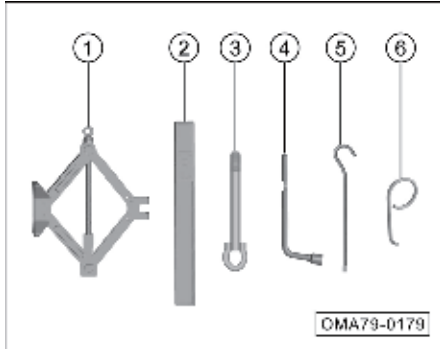

The following tools are provided in the trunk. After use, they shall be cleaned in time and placed back.

- ① Jack
- ② Warning triangle
- ③ Towing hook
- ④ Wheel bolt removal wrench
- ⑤ Special wrench for jack

- ⑥ Hub trim cover removal tool*

First aid kit*

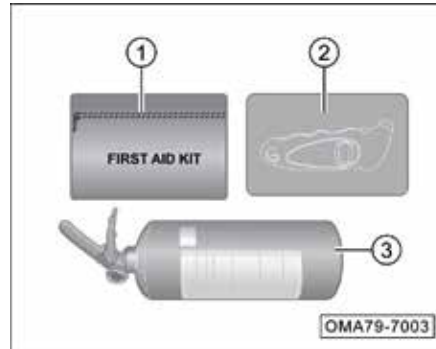

The first aid kit for this vehicle includes:

- ① Medical kit: containing emergency treatment items for external injuries, like medical gauze bags, medical tape, medical breathable bandages, triangular bandages, iodine cotton sticks, dressing forceps, safety scissors, etc. for hemostasis and bandages.
- ② Tire pressure gauge: used to detect tire pressure.
- ③ Portable dry powder fire extinguisher: used for emergency firefighting in case of vehicle fire.

Spare tire

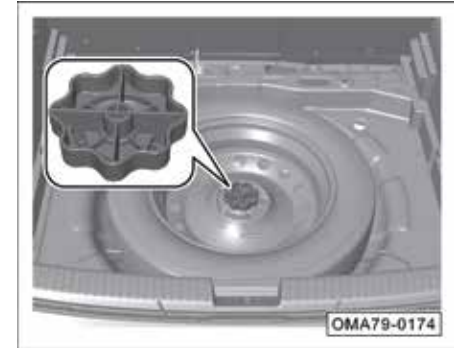

Remove the spare tire:

- Open the liftgate.
- Lift trunk carpet.
- Screw out the spare tire center handwheel counterclockwise and take out the spare tire.

8. Accident handling

i NOTE

– The spare tire has been inflated. Check its pressure regularly to ensure that it is at the specified maximum tire pressure, and perform multiple inspections every year.

⚠ WARNING

- Use the spare tire in strict accordance with spare tire requirements to avoid danger.
- It is strictly prohibited to install and use more than 1 spare tire at the same time.
- It is forbidden to use the spare tire that has been damaged or worn to the limit.
- The storage and service life of spare tires is 6 years. It is prohibited to use them beyond the time limit.
- After the spare tire is installed, check the tire pressure as soon as possible to make it within the specified range.
- The maximum speed of the spare tire shall not exceed 80 km/h and abrupt acceleration and emergency braking shall be avoided.

8.2 Use of warning triangle

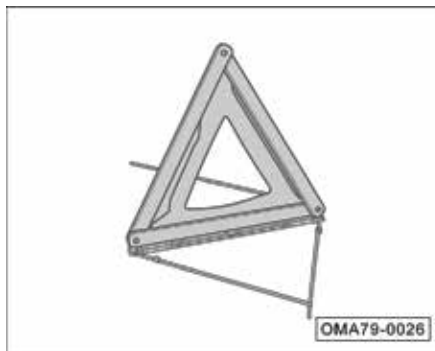

- Open the liftgate.
- Take out the warning triangle and unfold it for use.

Placement distance

Ordinary highway		Expressway
Daytime	Night	
≥50m	≥80m	≥150m

👁 CAUTION

The data above is for reference only. Please place the warning triangle at the distance specified by traffic regulations.

8.3 Use of reflective vest



OMA79-0027

- If it is necessary to stop the vehicle due to an accident or other failures, take out the reflective vest from the glove box to put on it well before getting off the vehicle for checking and troubleshooting.

i NOTE

- While handling vehicle accidents, be sure to wear a reflective vest as required to attract the attention of passersby or other drivers regardless of the lighting conditions.
- After using the reflective vest, please store it in the glove box properly. If necessary, clean it according to the indication on the collar mark to maintain the reflective performance.

8.5 Replacing flat tires

Preparations

- Apply parking brake
- Set the shift lever to “P” position.
- The START/STOP button is set to the “OFF” gear and the hazard warning lamp is turned on.
- Place a warning triangle in a suitable position behind the vehicle.
- Find a suitable object to wedge the wheel in the diagonal position of the one to be replaced to prevent the vehicle from moving.
- Take out the driver's tools and the spare tire.

⚠ WARNING

- **Relevant regulations must be strictly followed.**
- **All passengers must leave the vehicle and wait in a safe place.**

8. Accident handling

Unscrewing the wheel bolts

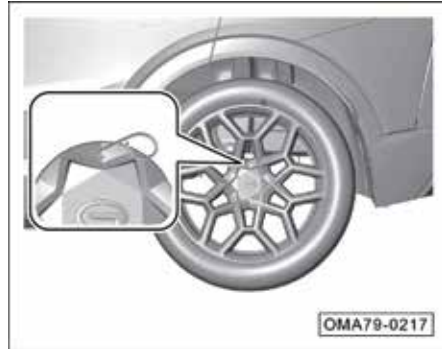

- For vehicles equipped with hub trim covers*, the trim covers need to be removed before removing the wheels. Pry open the trim cover from the small hole with the hub trim cover removal tool*.



Set the wheel bolt removal wrench firmly on a wheel bolt, and unscrew the wheel bolt counterclockwise.

CAUTION

Loosen the wheel bolts just one turn before lifting the vehicle. After lifting the car, unscrew the wheel bolts completely, and then remove the flat tire.

Lifting the vehicle

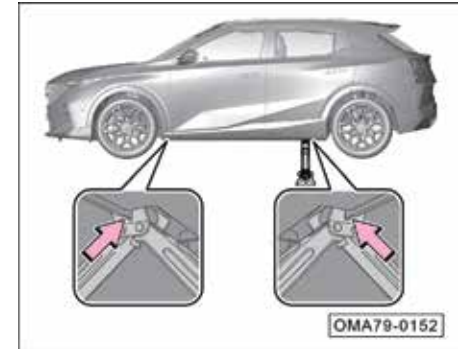

- Place the jack directly under the spine closest to the flat tire.
- Extend the jack high to ensure that the groove of the jack can engage with the spine.
- Check whether the jack is stable and tightly attached to the ground.

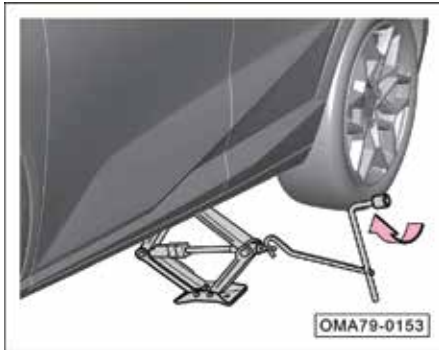

- Assemble the wheel bolt removal wrench, the special wrench for jack and the jack.
- Extend the jack clockwise to lift the vehicle and lift the tire off the ground.

⚠ WARNING

Improper use of jacks will cause serious injury.

- The jack must be used on a hard and flat ground or a hard pad (not thicker than 1 cm) may be placed under the jack as needed.
- Strictly observe the jack operation precautions.
- If the vehicle tows a trailer, the trailer must be separated from the vehicle.
- In the lifting process, the vehicle condition should be continuously observed. If the vehicle body is found to be obviously inclined, the lifting should be stopped and the problem should be found out. Lifting should be carried out only after the problem is solved.

⚠ WARNING

- The jack supplied with the vehicle can only be used to lift the vehicle, and cannot be used to lift other heavy objects or vehicles.
- When the jack is in use, do not start the engine; otherwise accidents will occur.
- When lifting the vehicle with a jack, remember not to place any part of the body under the vehicle to avoid accidents.
- If it is really necessary to work under the vehicle, proper protective support must be placed under the vehicle.

Removing the flat tire

- With the vehicle lifted, unscrew the loosened wheel bolts with the wheel bolt removal wrench.
- Replace flat tires.

8. Accident handling

Installing spare tire

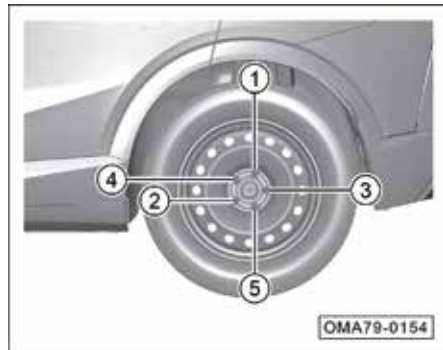

- Install the spare tire to the vehicle.
- Install all wheel bolts, and pre-tighten them with the wheel bolt removal wrench in the order of ① ~ ⑤ in the figure.
- Give a verbal alert to confirm that nobody is around the vehicle, and then rotate the jack wrench counterclockwise to lower the vehicle.
- Tighten all wheel bolts using the wheel bolt removal wrench.

- In order to avoid the noise of the vehicle during driving later on, please remember the locations of various tools, put them back in place after use and fix them.

CAUTION

After installing the wheels, go to GAC Motor authorized shop in time to check the tightening torque of the wheel bolts ($125\pm 10\text{N}\cdot\text{m}$); otherwise the bolts may be loose when the vehicle is driving, which is very likely to cause traffic accidents.

WARNING

- Threads on wheel bolts and hubs must be kept clean so that the bolts can be easily screwed and free of adhesions such as grease.
- During replacement of tires, if the bolts are rusty or difficult to screw, the bolts must be replaced and the threaded holes must be cleaned.
- After the spare tire is not in use, the spare tire must be reliably fixed at the original mounting place.

8.5 Fuse

Instrument panel PDU



- Remove the left lower guard panel (dotted shaded part) of the instrument panel. Then the fuse on the instrument panel PDU is visible.

Engine compartment power distribution unit (PDU)

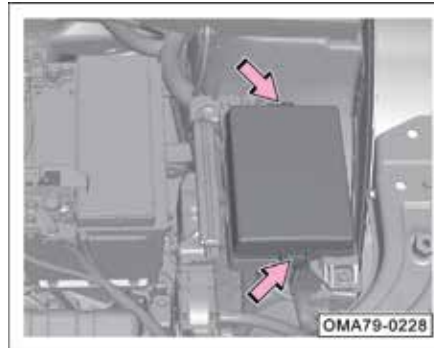

- Opening of engine hood
- Press the fixing clip in the direction of arrow to release the cover of the PDU.
- The fuse above the engine compartment PDU is exposed when the cover of the PDU is removed.

WARNING

Never clean the engine compartment fuse box with a high-pressure water gun.

Replacing fuse

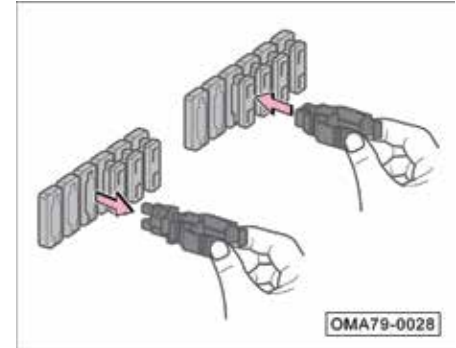

- Remove or install the fuse using the fuse puller in the engine compartment PDU.

8. Accident handling

Blown fuse

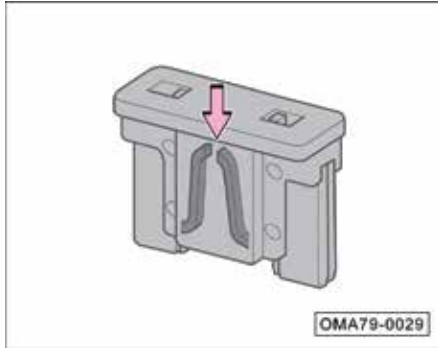

- If the fuse has blown (arrow indication), it is recommended to replace with a new one of the same color and sign at a GAC Motor authorized shop.

i NOTE

Some electrical consumers may be equipped with multiple fuses each, or multiple electrical consumers may share a single fuse.

👁 CAUTION

- All electrical consumers must be turned off before replacement of fuses.
- If it is required to replace the fuse, please consult the GAC Motor authorized shop.

⚠ WARNING

- Fuses must not be reused.
- Do not use a fuse with rated current higher than the specified value, otherwise other components of the electrical system will be damaged.
- Using an inappropriate or repaired fuse will cause a short circuit or even a fire.
- The color and logo of the replaced fuse must be exactly the same as the original one.
- Never replace a fuse with metal sheets, clips, etc.
- The inside of the PDU must be kept clean and moisture-proof.

8.6 Emergency start

Jumper cable

If the engine cannot be started due to low battery power, it can be started by connecting this battery to the battery of another vehicle with jumper cables.

CAUTION

Before the jumper cable operation, be sure to turn off all electrical consumers of the vehicle with power shortage, such as headlights, A/C, AV system, etc.

WARNING

- **The engine compartment is a high-risk area. Improper operation can easily cause casualties.**
- **Be sure to carefully read and observe the safety warning instructions related to battery operation before starting operation on the battery.**

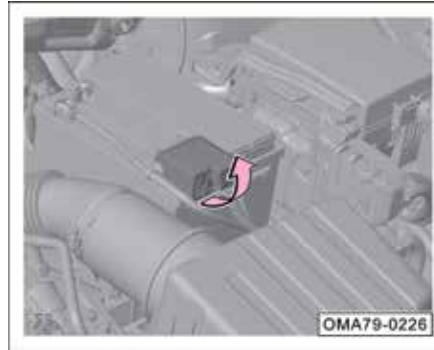

1. Open the engine compartment cover and flip up the cover of the battery positive terminal as arrowed.

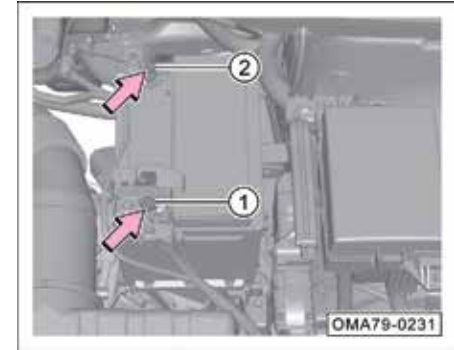

2. Connect the clamp of the red positive jumper cable to the battery positive ① of the vehicle, and connect the clamp on the other end to the battery positive of another vehicle; connect the clamp of the black negative jumper cable to the battery negative ② of the vehicle, and connect the clamp on other end to the engine block of another vehicle or a metal part firmly connected to the engine block of another vehicle.
3. Start the engine of the vehicle with power battery and let it idle. Then, start the engine of the vehicle with the depleted battery till the engine runs smoothly.
4. After the engine runs smoothly, remove the jumper cables in the reverse order.

8. Accident handling

CAUTION

- While connecting the batteries of two vehicles, be sure to first connect the positive terminal and then the negative terminal.
- Properly place the jumper cable to avoid contact between the cable and the moving parts of the engine.

WARNING

- **Be sure to turn off the headlamps before removing the jumper cables.**
- **Turn on the blower and rear windshield heater of the vehicle with the depleted battery to reduce the voltage peak generated when the cable are being removed.**
- **Remove the jumper cables with the engine running in the reverse order.**

WARNING

Improper use of jumper cables may cause battery explosion and serious injury.

- **The voltage of the power battery must be the same as that of the depleted battery, and the capacities of the two batteries shall also be the same. Otherwise, explosion may be caused.**
- **Never expose the battery to an open flame, for fear of an explosion.**
- **Never connect the negative cable directly to the negative terminal of a depleted battery. There shall be no static electricity near the battery. Otherwise, the combustible gas produced by the battery may be ignited by sparks, causing an explosion accident.**
- **Never connect the negative cable to a fuel system component or a brake line. Never lean over the battery during operation. Be careful not to get burned by acid.**

WARNING

The jumper cable should be correctly connected to the positive and negative battery terminals according to the above instructions. It should not be connected to other parts of the battery; otherwise, it may cause fuse ablation or partial function failure of the vehicle, which will not be covered by the warranty.

8.7 Vehicle towing

If the vehicle needs to be towed, it shall be towed by the GAC Motor authorized shop or a professional towing company.

It is recommended to use a rollback tow truck for towing. If the conditions can not be met, a wheel-lift truck can also be used for towing the vehicle as appropriate.

Being towed by a rollback tow truck

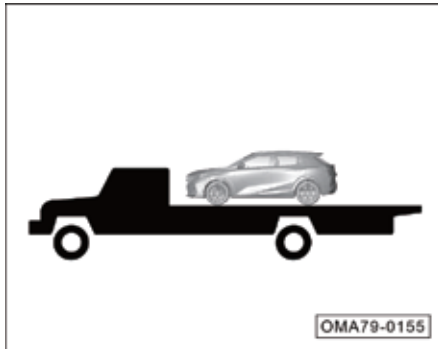

Being towed by a wheel-lift truck from the front

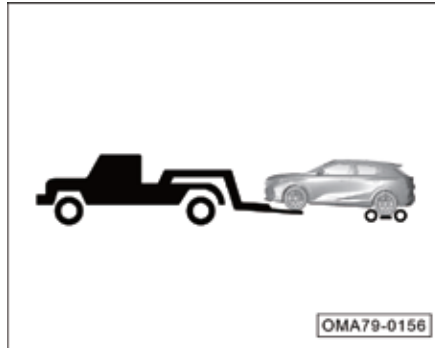

- Place a dolly under the rear wheels.

Being towed by a wheel-lift truck from the rear

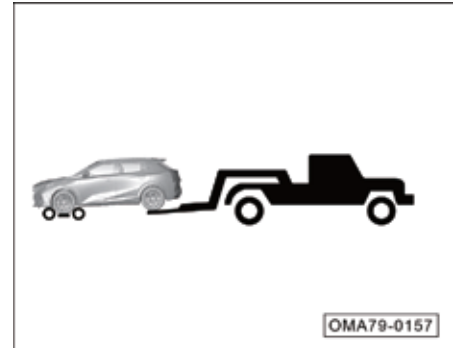

- Place a dolly under the front wheels.

8. Accident handling

Emergency towing

If it is impossible to find a tow truck in an emergency, fasten the towing cable or towing chain in the emergency towing ring to temporarily tow the vehicle. However, this method is only suitable for low speed and short distance towing on a solid and flat road.

 **WARNING**

In emergency towing, drive slowly to avoid violent operation. Excessive towing force will damage the vehicle

Installing a towing hook



- Pry off the towing hook cover at the arrowed position using a slotted screwdriver wrapped with a cloth.



- Take out the towing hook ① and wheel bolt removal wrench ② from the driver's tool kit in the trunk.
- Screw the towing hook ① clockwise into the thread hole.
- Insert the wheel bolt removal wrench ② into the round opening of the towing hook, and turn the wheel bolt removal wrench clockwise to make the towing hook be firmly screwed into the thread hole.

Precautions for towing

Before emergency towing, be sure to follow the instructions below:

- Hazard warning lamps of both towing and towed vehicles must be turned on and local traffic regulations must be complied with.
- The towing hook must be firmly tightened in the thread hole. Otherwise, the towing hook may slip out of the thread hole during towing.
- The towed vehicle must be shifted into "N".
- For the towed vehicle, set the START/STOP button to the "ON" position and turn the steering wheel back and forth to confirm that the steering wheel can be turned.

During the emergency towing, be sure to follow the instructions below:

- Start the engine and drive at a slow speed till the towing rope is tight and then accelerate the vehicle slowly.
- Be sure to drive steadily and avoid sharp acceleration, sharp deceleration or abrupt turning.
- During towing, the towed vehicle shall be braked earlier than in normal conditions with the brake pedal lightly depressed.
- During towing, the towing rope must always be in a tight state.

8.8 Getting out of a trap

If the vehicle is stuck on a soft road such as sandy, muddy or snowy road, follow the steps below to get out of a trap:

1. Observe the areas in front of and behind the vehicle to ensure that there are no obstacles.
2. Turn the steering wheel to the left and to the right to grind areas around the front wheels to remove mud, snow or sand trapped around the tires.
3. Place wooden blocks, stones or other materials to help increase tire friction.
4. Start the engine and accelerate the vehicle slowly to get the vehicle out of the pit.
5. If the vehicle still cannot get out of the trap after attempts for several times, it is required to have a tow truck for rescue.

i NOTE

In the acceleration process, human assistance can be provided to push the vehicle from the front and rear for driving the vehicle out of the trap.

This manual describes related information of entire GAC Motor series, including their configuration, functions, performance parameters and product schematic diagrams. Its content is valid when allowed to be printed. However, the actual configuration and function of the vehicles are subject to the specific vehicles delivered. If there is any difference between the schematic diagrams and the specific vehicle delivered, the actual vehicle shall prevail.

GAC Motor Co., Ltd. reserves the right to change, supplement or terminate the contents and technical specifications in this manual without prior notice.

GAC Motor Co., Ltd. owns the copyright of this manual. Without the written consent of GAC Motor Co., Ltd., it is not allowed to photocopy or extract the contents of this manual.

GAC Motor Co., Ltd.